

Celebrating

WaveLAN

Precursor of Wi-Fi

1987

IEEE MILESTONE

SYMPOSIUM

Wi-Fi Past, Present & Future

NIEUWEGEIN 29 OCTOBER 2019



COLOPHON

This book has been published on the occasion of the symposium

Wi-Fi Past, Present & Future

on 29 October 2019, Nieuwegein, the Netherlands

ABOUT THE AUTHORS

The authors in this book are the speakers from the symposium and their articles reflect the content of their presentations.

ABOUT OUR SPONSORS

Organizing the celebration of the invention of WaveLAN and the dedication of the Milestone Award plaque comes with a cost.

The symposium and this publication has been generously supported by the following sponsors:

IEEE

Municipality of Nieuwegein

Nokia

Qorvo



Benelux Section



Benelux Chapter on
Signal Processing



Benelux Chapter on
Information Theory



Benelux Chapter on
Communications and
Vehicular Technology

Nieuwegein



NOKIA

QORVO



PREFACE

Dear Guest,

The organizing committee of the symposium “Wi-Fi, Past, Present and Future” is glad that you joined us in Theatre “De Kom” in Nieuwegein. This symposium is organized to celebrate the dedication of the IEEE Milestone Award “WaveLAN, Precursor of Wi-Fi”. IEEE, the world’s largest technical professional organization, honours significant technical achievements in all areas associated with IEEE. Milestones recognize the technological innovation and excellence for the benefit of humanity found in unique products, services, seminal papers and patents. Moreover, these developments must have stood the test of time for at least 25 years.

I believe, that besides the transistor, Wi-Fi is one of the greatest inventions of the twentieth century. Nowadays, people can hardly imagine how life would be without it. The ubiquitous Wi-Fi technology is used to wirelessly connect all types of mobile devices to each other and to the internet and it operates in businesses, hotels, stations, restaurants, shops, public buildings, residences, in trains and even in airplanes etc. This technology brings ease of access to information supporting both the professional workforce as well as people seeking entertainment.

The IEEE Benelux Section is proud to now have a third milestone award in its territory. The first one was for the CD player, the second for the discovery of superconductivity, and now we have this one for WaveLAN. It was quite an effort to go through all the steps of the application procedure. First of all we had to overcome local hurdles and then we had long negotiations with the IEEE History Committee where to place the award plaque. We are pleased with the generous cooperation of the municipality of Nieuwegein. This enables placing the plaque in its town hall, near the building where it all began, namely the NCR development lab at the Zadelstede. Today, the members of that lab who contributed to the development of WaveLAN will share interesting historical details and epic stories. Moreover, experts will show where the technology stands today and give you a glance into future developments.

In the afternoon the president of the IEEE and the mayor of Nieuwegein will unveil the Milestone Award plaque, which will be the culmination of the symposium.

I would like to thank my fellow members of the organizing committee, Elly Schietse, Vic Hayes, Cees Links and Willie van Dam, for attending the several meetings, but even more for all the work they did to make this symposium a success.

We wish you an interesting and useful day.

Wim van Etten,
Chairman of the Organizing Committee

TABLE OF CONTENTS

Licensed or unlicensed	Michael Marcus	2-4
Early WaveLAN products	Bruce Tuch	5-11
Insights on the first years of IEEE 802.11	Vic Hayes	12-15
WaveLAN, the foundation of global wireless LAN utility	Dorothy Stanley	16-17
Crossing the chasm into the Wi-Fi tornado	Angela Champness	18-20
Wi-Fi Now and future	Claus Hetting	20-21
Importance of the IEEE milestone program	José Moura	22
WaveLAN to Wi-Fi - Essential part of daily life	Edgar Figueroa	23-25
Wi-Fi - Making the difference	Cees Links	26-29
IEEE at a glance	Wim van Etten	30-31
IEEE milestone plaque		32

Licensed or Unlicensed

By Michael J. Marcus

This article deals with the early history of civil spread spectrum policy and systems including the questions of whether it should be licensed or not. We were focusing at the time on modifying spectrum policy to remove an implicit prohibition on any spread spectrum technology due to the assumption that FDMA was the only way to share spectrum among users. We did not have a clear vision of what spread spectrum uses would be commercially viable, but thought that there would be niche applications, e.g. wireless cash registers in department stores, where it would be attractive.

We were not thinking about wireless LAN's for the simple reason that when this effort started around 1980, there was little commercial interest in any type of LAN! Thus while commercial ethernet existed at that time, its use outside of R&D labs and computer centers was almost nonexistent. Ultimately spread spectrum was used under unlicensed regulation in Wi-Fi, Bluetooth, and many lesser known technologies but also in the Qualcomm 2G CDMA cellular, and all the 3G cellular systems. However, in the 1970's and early 1980's any civil use of this technology seemed doubtful. Indeed in May 1991 there was a landmark IEEE conference held in Quebec entitled "Spread Spectrum Potential Commercial Applications: Myth or Reality", which documents that at that time there were real questions about its viability in the commercial world.

The 1970's

Like computer technology, spread spectrum technology has a long complex history with no clear single "eureka" moment or inventor. The Hedy Lamarr story of invention is limited to frequency hopping versions of spread spectrum and thus is more relevant to Bluetooth than Wi-Fi. Military R&D at MIT Lincoln Laboratory, Sylvania Electronic Systems, and Magnavox Government and Industrial Electronics in the 1960s for jam-resistant and covert communications systems, produced many of the key technical details and early U.S. military systems such as the AN/ARC-70 and AN/ARC-90. Much of this technology was focused on addressing a repeat of the Berlin Airlift. However, parallel radar technology - where the concept is called "phase coding" - also had an impact. But since most early work was classified, the origins have been confusing for a long time.

I first got involved in spread spectrum technology in depth in 1975-79 while working at the Institute

for Defense Analyses, a Pentagon think-tank, on options to protect military units from communications jamming. Events in the 1973 Mid East War had raised concern in the U.S. military about this issue - which had been neglected since WWII. At that time the only comprehensive discussion of spread spectrum technology was a classified textbook-like document from Sylvania.

The 1976 publication of Spread Spectrum Systems by Robert Dixon was a significant milestone in the commercialization of this technology. Previous publications were either classified military reports or academic papers on narrow subtopics. Dixon's book was the first comprehensive unclassified review of the technology and set the stage for increasing research into commercial applications. It did not go into much technical depth but served as a road map to published papers that explained technical details without much context.

The late 1970's were the beginning of an era of deregulation for the Federal Government in general. Cornell University Prof. Alfred E. Kahn's thinking on the economic benefits of deregulation were influential throughout Washington. As a result, FCC Chairman Charles Ferris wanted to decrease the role of FCC in spectrum policy and stimulate new services and technologies. He was concerned about promising technologies that were being held back by anachronistic regulation that discouraged their consideration and the capital formation necessary for their further development.

Ferris' incoming technical czar, former ARPA Director Stephen Lukasik, and I met unexpectedly in the summer of 1979 at a classified Army-sponsored meeting on electronic warfare (EW) issues we had been independently invited to. We had met several

Date Appr.	Company name	County	Datarate
1988-07-09	Telesystems	Canada	
1989-02-10	Life Point System Inc	US	
1989-03-16	X Cyte Inc (4 units)	US	
1989-04-08	NYNEX Corp	US	
1989-04-08	O'Neill Communications	US	38.4 kbit/s
1989-05-09	Cirronet (Gambette)	US	
1989-06-13	Telesystems	Canada	
1989-08-11	Telesystems	Canada	
1989-12-18	Agilis Corporation	US	230.4 kbit/s
1990-01-10	Intermec (4 units)	US	
1990-01-23	Telesystems	Canada	230.4 kbit/s
1990-02-11	Symbol Technologies	US	
1990-04-12	Verifone (2 units)	US	
1990-05-11	Symbol Technologies	US	60.0 kbit/s
1990-07-23	Life Point System Inc	US	
1990-09-24	Agere Systems (NCR)	Netherlands	2,000.0 kbit/s

Early FCC approvals for Spread Spectrum devices

years earlier when he was Director of ARPA (now DARPA) and I was a junior Air Force officer spending his money on underground nuclear test detection research. Interested in my thoughts on EW issues, he asked me what new radio technologies should the FCC be thinking about for removing outdated barriers. Thinking for a few days, I responded to him: spread spectrum, adaptive antennas (e.g. today's MIMO), and millimeter waves (frequencies >30 GHz). I soon had my ticket out of the U.S. military industrial complex and into FCC!

The 1980's

Initial commercial use of spread spectrum began independently in the 1980s in the U.S. with three systems. Each was specifically authorized by FCC based on narrow specific circumstances. Two were satellite systems in which the satellite operator already had effective ownership and management of the spectrum involved. But general spectrum management policies in the U.S. and elsewhere made spread spectrum use in other contexts doubtful and the general technical consensus at FCC and in industry was that CDMA was inefficient in the real world. (It turned out that the CDMA power control that Qualcomm pioneered changed the assumptions that led to this conclusion.)

Chairman Ferris approved the spread spectrum initiative that Dr. Lukasik and I proposed to him. The basic goal was to remove regulatory barriers to spread spectrum and CDMA in order to encourage R&D on practical systems, while maintaining interference protection for conventional users as our initial concepts were broad enough to include what today would be called UWB. As specific systems were developed, they could be considered on their merits. But if FCC did nothing, it was feared that the "regulatory risk" of approaching the FCC "cold" was so great that it discouraged investment and R&D.

The first overt FCC action in this direction was a study that FCC contracted with MITRE Corporation to write: "Potential Use Of Spread Spectrum Techniques in Non-Government Applications" (MTR80W00335) This report was released on December 1st, 1980.

The MITRE report, written by Walt Scales, has the first written reference to the possible use of the ISM bands for spread spectrum commercial applications. However, it does not explicitly mention unlicensed use of these bands as the report focused on technical issues. The \$55,652 spent by FCC on this report was one of the best investments ever made by the U.S. Government! (Unfortunately, in the decades since this report was done, FCC has never had the

funding to support other reports on promising wireless technologies.)

Following the MITRE report, FCC staff prepared a Notice of Inquiry under my direction and it was approved on June 30, 1981, initiating Docket 81-413. A parallel proceeding, Docket 81-414, examined spread spectrum in the context of amateur radio.

While today's FCC dockets are online and the FCC documents and public comments can be reviewed through the FCC website, documents from this era are only available by special request to the National Archives. Basically, most of the comments were very negative - foreshadowing what would happen two decades later in the context of UWB. Part of the NOI was similar to the later idea of UWB "underlays".



Dr. Michael Marcus presents the proposed rulemaking to the FCC Commissioners

Regrouping, we drafted a May 21, 1984 Notice of Proposed Rulemaking that narrowed the proposals and included the specific context unlicensed use of the 3 ISM bands. A major reason was to give spread spectrum someplace to start since everywhere else there was a bad NIMBY (not in my backyard) problem. (Even the predecessor of today's Consumer Technology Association (CTA) opposed the proposals fearing that FCC would act on it and then ignore their pending proposal for more spectrum for mediocre FM-based cordless phones at 48 MHz. Ironically 48 MHz phones, have totally disappeared from the U.S. marketplace, replaced for a while by ISM band spread spectrum units, and now by DECT technology.)

The world's first general authorization for civil spread spectrum was in the May 1985 in FCC Docket 81-413. This included the rules that Wi-Fi, Bluetooth, and a variety of more specialized systems. A slight variant of these rules is widely used for electronic reading of utility meters by nearby utility vehicles. The first commercial product under these rules was a 1988 900 MHz RLAN by a newly formed Canadian

company Telesystems which was about 1/10th the speed of the later WaveLAN (see table below). This was followed by a variety of systems from different developers using various types of modulations in various ISM bands with various protocols. There were generally not interoperable even though they used common spectrum.

Ultimately Wi-Fi and then Bluetooth became both ubiquitous and the most common technologies using the new regulations which proliferated around the world. While the original rules focused on spread spectrum promotion and only allowed this technology in the ISM bands, the combination of the need for higher RLAN speeds and the commercial success of CDMA cellular made clear it that the preferential treatment of spread spectrum in the ISM bands, that was the original goal was no longer needed and FCC deleted that as a mandate in the early 1990s.

Concluding thoughts

We never considered in the original policy development the issue of RLANs, yet this turned out to be the largest impact of these rules. Similarly, we never contemplated how any use of this new unlicensed spectrum would impact society and the workplace as much as Wi-Fi and Bluetooth have. In creating a band and a technical framework where spectrum could be used for short range communications for virtually any use with only routine transparent technical approval we created a “safety valve” that would allow timely development of new spectrum uses that the traditional spectrum policy structures could not respond to effectively. Previously, most new uses required time consuming changes in national and possibly international regulations.

Seeing new and unexpected uses of Wi-Fi and Bluetooth in education and many other areas shows that this effort had impacts far greater than any of us expected and shows that the “planning” approach of traditional spectrum management is not able to get the full benefits of spectrum for societies and economies. It is interesting to compare the long term results of FCC’s deregulatory approach with the results of the European government-sponsored HiperLAN effort which specifically focused directly on RLANs but was a commercial failure. The FCC action unexpectedly triggered a multinational technological Darwinism for efficient practical RLAN technologies. WaveLAN, the precursor of Wi-Fi, and Bluetooth (which was able to readily share spectrum with Wi-Fi) were the winners of the Darwinistic competition using the Adam Smith’s “invisible hand” for technology selection, rather than the traditional mechanisms of national and interna-

tional spectrum management with “requirements” and drawn out consensus building by governments. While traditional spectrum management has many good features, the shining success of WaveLAN/Wi-Fi shows that for some types of rapidly developing technology Darwinism with less government involvement in the details works better.

European spectrum policy and industrial policy achieved great worldwide market success with both GSM and DECT, but the similar success of WaveLAN/Wi-Fi shows that sometimes market Darwinism also has great success!

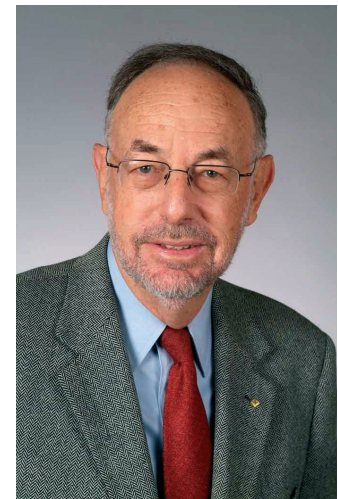

Michael J. Marcus

Sc.D., F-IEEE

Adjunct Professor

Bradley Department of Electrical and Computer Engineering, Virginia Tech, Blacksburg, VA USA
(US) Federal Communications Commission (Retired)

Michael Marcus was overeducated in electrical engineering from MIT. Prior to working at FCC for almost 25 years, he worked at Bell Labs, served in the U.S. Air Force, and analyzed electronic warfare issues at the Institute for Defense Analyses. At FCC his work focused on proposing and developing policies for cutting edge radio technologies such as spread spectrum/CDMA and millimeter-waves. Wi-Fi and Bluetooth are results of his early leadership. He is now Director of Marcus Spectrum Solutions LLC, an independent consulting firm based in the Washington DC area and focusing on wireless technology and policy. He also teaches at Virginia Tech.

He was recognized as a Fellow of the IEEE and received in 2013 the IEEE ComSoc Award for Public Service in the Field of Telecommunications "For pioneering spectrum policy initiatives that created modern unlicensed spectrum bands for applications that have changed our world."

Early WaveLAN Products

By Bruce Tuch

We are here for the IEEE Milestone Award for WaveLAN (the precursor of Wi-Fi). I would never have imagined back in 1987 as an RF engineer when I first started on a “feasibility study” for the “Wireless Project” in NCR (Nieuwegein, the Netherlands)¹ what that seed would grow into. Looking back at the technical direction, there are always some “key moments” that occur that set the path forward. Here I focus during the early days of WaveLAN and eventually the first IEEE 802.11 products and its directional impact ²:



Milestones

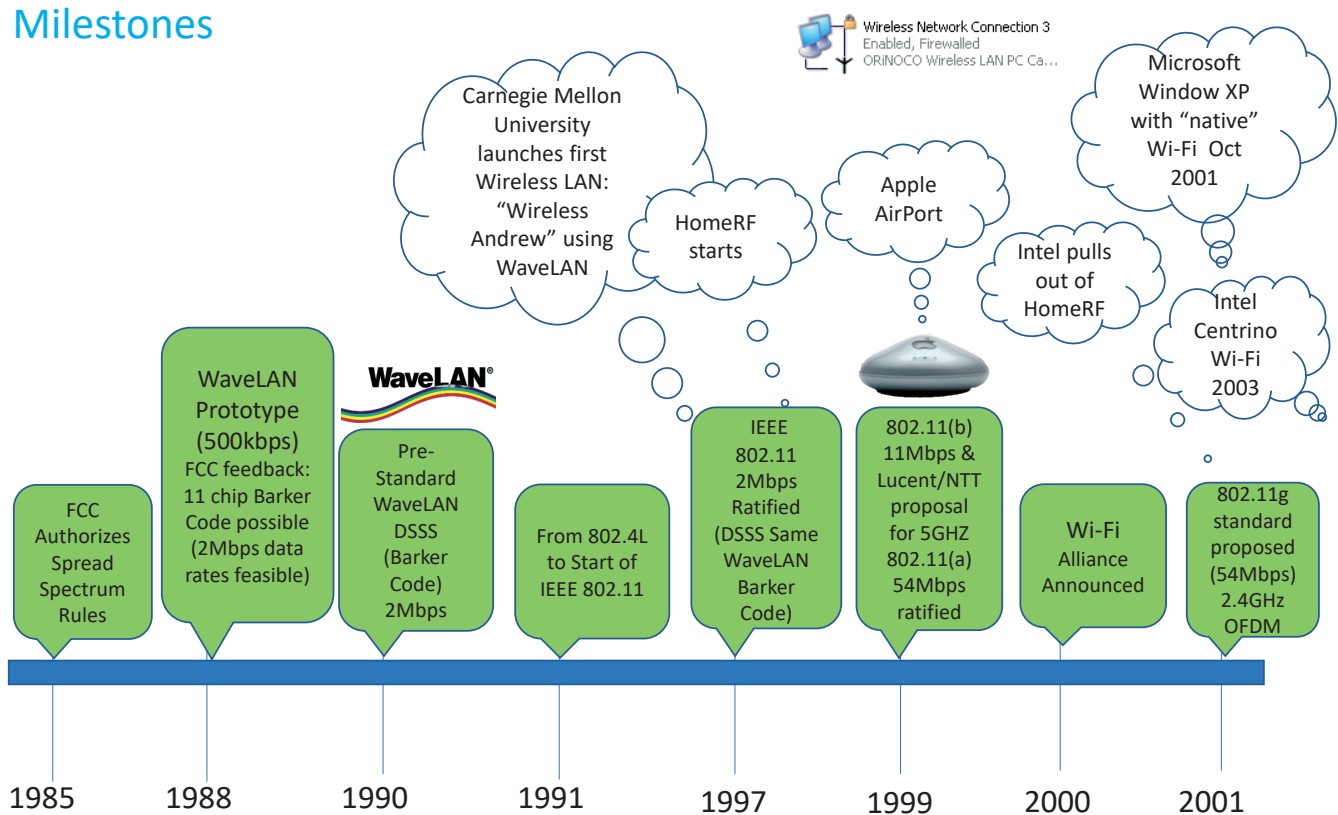

Prototype and 1st WaveLAN product (Yes it will work!)

In 1985 the FCC authorizes spread spectrum in the 902-928MH, 2400-2483MHz and 5725-5875MHz unlicensed frequency bands, with significant power levels for communications.

Can we make this work for data communications? That was the question by NCR who allocated the task of a feasibility study by the Wireless Communications Division in the Netherlands (to use for cash registers

to communicate without wires). Indoor propagation measurements were done, and models created to predict range and performance, using the new FCC rules. It looks promising and prototype board made to “show it is real” to management in Ohio.

The first prototype worked up to 100kbps in 1987, and we also later modified the Spread

¹ Due to corporate acquisition & restructuring NCR and the Wireless Communication and Network Division associated with this moved into AT&T, Lucent and then Agere Systems it was the same team in place headquartered in Nieuwegein throughout this journey.

² For a much more detailed review I would recommend the book “The Innovation Journey of Wi-Fi” Edited by Wolter Lemstra, Vic Hayes, John Groenwegen Cambridge University Press.

WaveLAN prototype and Engineering lab book block diagram

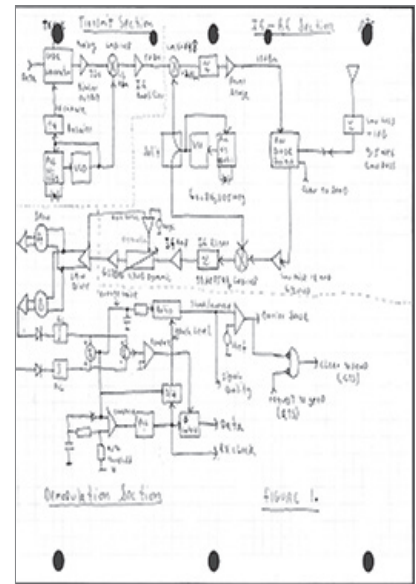
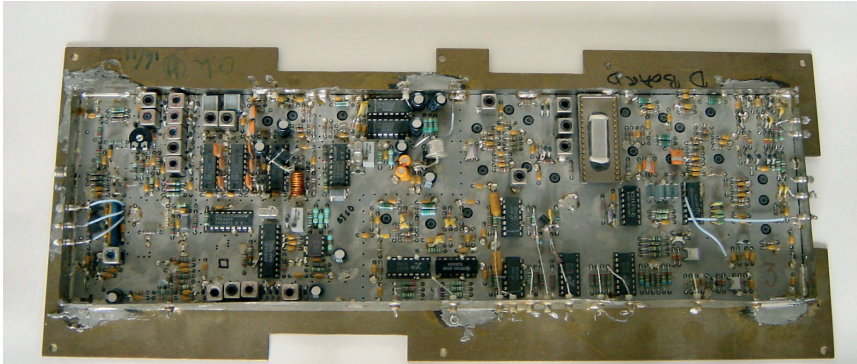

Spectrum parameters up to 500kbps, but for Data Communications the wired Local Area Networks then were a minimum of 1 Mbps (StarLAN) with 10Mbps Ethernet (10BASET) getting more traction. To facilitate a seamless application replacement with wireless, we really needed to break the 1Mbps barrier. We knew we can extrapolate the system to higher speeds, but can we achieve 2Mbps within the framework of the FCC Spread Spectrum rules?

I took a trip to the Washington offices off the FCC (1988), arranged by Don Johnson NCR Technology Center Headquarters, our NCR prototype sponsor, to talk with the engineers responsible for the interpretation and compliance of the new FCC Spread Spectrum rules. As being a new area, there was uncertainty on exactly how much they required to “Spread the Spectrum” and how it should be measured. The term used to measure Spread Spectrum, how much more spectrum bandwidth had to be transmitted than the actual data bandwidth needed, is called “processing gain”. If the requirement was set too high it would be difficult to have Local Area Network-like data rates.

After asking my question many times what the minimum number is needed to “spread the spectrum” I did not hear the usual numbers used for antijamming applications (>127x) but only 10 and a method they would use to confirm it in the receiver implementation. Great joy as I danced out of the FCC technical compliance teams’ room.

Back “home” in Nieuwegein we set to find the best method to get to that minimum. A design engineer in our team, Hans van Driest, found over the weekend a code that was 11 long (so spread just above the 10x criteria) and had all the needed properties for robust indoor communications. (Turns out he “reinvented” a known code used in radar systems

called the Barker code). Once I saw this code my heart “skipped a beat” as I knew this was a defining moment to get a differentiated product developed.

1st products developed

Early PC inserted Card to WaveLAN PCMCIA cards (with Antenna)

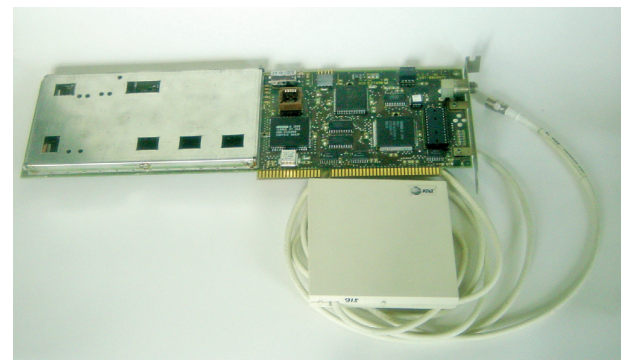

The 1990's was the phase of technology development for wireless using the vertical "retail" channel as the incubator for this newborn child. We got the technology to work and placed in "wireless cash registers" at the amazing speeds of 2 Mbps. Notebooks just started to enter the market and we adapted quickly with PCMICA (credit card slot for the notebook) first with an external Radio section (we did not yet have the level of integration needed, nicked name for this was "soap on a rope") and later integrated with small extension for the Antenna.

➤ **Future 802.11 journey impact**

- Approval and interpretation of the FCC rules to allow higher data rates using the Direct Sequence Spread Spectrum (DSSS) rules, breaking the 1Mbps barrier. WaveLAN was the first FCC certified product at 2Mbps which was the "existence proof".

Mike Masleid from Inland Steel and I worked out in a late-night session a proposed mechanism to support wireless using the 802.3 (Ethernet) standard. After internal tutorials to the 802.3 group (all more focused to get the next 100Mbps wired standards done) they did not show strong support. This was fine, as it was much better to make a new protocol focused and optimized for wireless.

The stage was set for a new MAC standard 802.11, and Vic Hayes took on the role of Chair in 1990 which he would serve during the total 10 year term. Still technical battles had to be won, key being a Centralized (central polling coordinator) or Decentralized (Carrier Sense Multiple Access) approach. WaveLAN was already decentralized as we believed from our testing and modeling this was the best approach given the wireless and spectrum properties (a shared and "democratic" spectrum policy).

Going from 802.4L to a dedicated 802.11 wireless standard

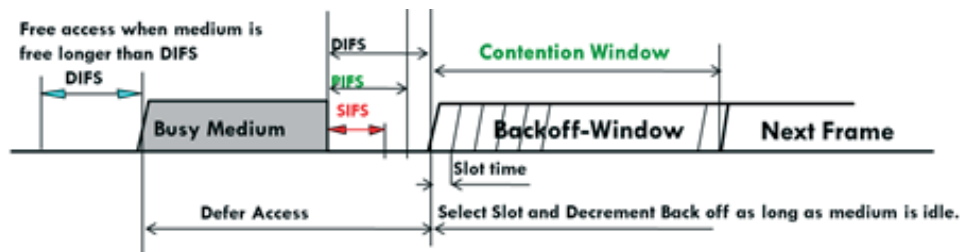

CSMA protocol (as used in 802.11)

We knew that to make this a larger market play, a standard would be needed, and the NCR policy was to support standardization and open systems (a reaction to IBM, also competing with NCR in the retail space). LAN standards were driven by IEEE 802 and there was a wireless standard in place, token bus 802.4L, that was looking for new opportunities to apply this for wireless. The group was small, and the chair no longer attended. Vic Hayes (Senior Consultant Standards at NCR Nieuwegein) took over the chair of this wireless task group.

The WaveLAN product used a Medium Access Control Protocol (MAC) of Carrier Sense (similar with the 802.3 Ethernet Standard). I was skeptical going into the 802.4L meeting and was reinforced that this "was not a suitable standard fit for purpose". So, all we needed to do now is convince the IEEE 802 executive committee that we need a new MAC to solve a different problem that other MAC standards could not solve. The team of engineers in the 802.4L group agreed with this and many would be part of the next move.

Wim Diespstraten, Senior Protocol Engineer and later Manager of the MAC Protocol Team in Nieuwegein, was one of the leaders in this work which did "win the day".

Also, the Physical Layer "radio standard" for 2Mbps data rates was adopted, Jan Boer (Signal Processing Engineer in Nieuwegein) was key driver in this standard work. This Direct Sequence Spread Spectrum (DSSS) Approach was very similar to WaveLAN technology (using a Barker sequence) achieving 2Mbps with a robust range.

Also a 1 Mbps Frequency Hopping Approach was part of the first 802.11 standard, our view was that the DSSS approach would lend itself to more capacity and further data rate expansion in the future, so we did not have any focus or development on this frequency hopping option in the standard.

► Future 802.11 journey impact

- A focused wireless only LAN standard 802.11 is born
 - Protocol based on a Distributed CSMA architecture robust for Wireless and posed to expand in the future
 - Future improvements including security 802.11i and QoS 802.11e used this framework
- A robust DSSS 2Mbps conforming the new FCC Spread Spectrum Rules for maximum data rate applications. Later versions from 802.11b 11Mbps and 802.11g/a 54Mbps all used this as the guiding definition for further expansion using Direct Sequence Spread Spectrum rules and expanded interpretation of “Processing Gain” to achieve higher data rates.

802.11b & breaking the 10Mbps barrier

Apple AirPort design industry catalyst

Apple had a wireless program during early 1996-time frame for a “1Mbps Frequency hopping” standard but their development never took off inside the company and they stopped. When Steve Jobs was asked back to Apple at end of 1996, he was looking for something unique to associate with their new entrance into the notebook market with the iBook launch and wireless connectivity became an interest. He brought in Dick Allen to help them get this done, but this time looked for “best in class” supplier to integrate the technology first. I remember Dick well, when he started “Photonics”, a start up doing Wireless but using InfraRed light technology instead of Radio. We had our first Wi-Fi/IEEE 802.11 standard 2Mbps products. It was the “evangelical” phase to get the message out that Wireless LAN would “change the way you do business”.

I was on a panel giving my pitch and the fact that RF (which also was part of the IEEE 802.11 standard) was the only “real solution” that would meet the user needs. Dick of course disagreed and we had some nice public debates, but it was always with respect, both on and off stage. Photonics eventually stopped; due to the physics, you just could not transmit through the walls, let alone floors, and the sunlight through the windows even hurt open space range. Dick also attended the IEEE 802.11 meetings with a keen interest on the RF standard. I remember lots of discussions on my RF propagation models I submitted: “hey Dick you can see this really does go through walls also” would be the tease.

It was getting really exciting late 1998, the IEEE 802.11b working group adopted the 11Mbps technology direction, which was a real “bloodbath”

in terms of the infighting. Luckily the standards body at this time had two major players (Lucent Nieuwegein & Harris) who, if we managed to stop the mud wrestling could get the ship moving again. This happened as both worked on a joint proposal which became the Wi-Fi 802.11b standard. Both companies then had to start to redevelop their chipsets used for product, so all focused on getting the development machine moving full force to get our 11Mbps going and there was still competition from different technologies, Home-RF, Bluetooth WLAN all 1 to 2Mbps data rates, so the more critical to get 11Mbps completed.

Getting this into the mainstream was important and Apple was just at the right time. Dick knew that the 11Mbps standard was close and development ongoing, if Apple worked closely with their “chosen



supplier” in parallel with the next generation development Apple could be first to market with an 802.11b 11Mbps integrated wireless notebook. This is typical for Apple, especially with “Steve back”, show leadership in sexy new applications. Dick and I spoke, and he also knew that we were “best in class” in terms of our radio development so far and the 802.11b program was ongoing. I did not know it then, but besides starting discussions with our sales teams, he got things moving at the highest levels.

Steve Jobs contacted the CEO of Lucent, Rich McGinn, for a talk about Wireless LAN. Cees Links, the VP running the business, got the call to come over with McGinn. Rich McGinn was surprised that Apple wanted to talk about WLAN, Cees had to give him some quick education on what we were doing, as this was always a “step child” to Lucent with at best “let them play” attitude as long as it did not hit the bottom line.

During a meeting in California, Steve said what he wanted: “Lucent you can help us but make sure we can sell this for \$99 retail. Thanks and goodbye.” (The WaveLAN 2Mbps card was selling for more than \$450 at that time).

Angela Champness (Director of Marketing) burst into my office with her understandable and contagious enthusiasm: "Bruce I think we can get the Apple deal, but we got to get the cost of goods down to \$50 range"... we were just in our development process in which more integrated Radio Technology would be applied, one chip RF integration was a technology risk. I took out my spreadsheet and looking at the last progress on the testing of our chip technology, it looked close but it would also depend on getting volume to drive the component price. We agreed that we needed to "go for it" so the proposals were aggressive while the teams worked to make it happen.

Working with Apple was an experience for all: strong negotiators on the purchasing side and working very close on the engineering, since it was all new and "breaking edge". The end design "look and feel" was all Apple of course and the requirements, even if impossible would still be hammered until something broke or you managed to get it done. Those in the Apple team knew that Steve sometimes had a "reality distortion field" around him and you just had to deal with it. Apple was quite transparent, and I found that refreshing, they all had goal to achieve and would move anything that got in their way.

I recall when Jon Rubinstein, Apple's Senior VP of Hardware Engineering, on a visit to Nieuwegein "to check us out" told me: "Bruce we will help you in any

way needed, but you will be so busy that after this first generation AirPort Card (and your associated chip development) is completed we would already have started on the next one with a different team".

Also in one of the California overall engineering progress meeting Tim Cook (then COO of Apple) popped in and told me: "We have some advantage with only 10% PC market share. With an enthusiastic and dedicated customer base and with the right product it is easier to gain market share, and we don't need to be the largest." At that time our AirPort Wireless Cards were going into Apple's iBook (mobile phones where not yet in the picture). This shows how things have changed for Apple since!

Well, we got it done and the Apple AirPort launched with Steve Job at Mac World July 21, 1999.

➤ **Launching 802.11b 11Mbps & Apple impact**

- Broke the magical 10Mbps barrier showing that Wireless can and will be able to keep pace with the needed Data Applications.
- Apple launching at \$99 price point not only put 802.11 as "the wireless Standard" but justified the technology that can meet the market price needs and scale accordingly. This was the last "nail in the coffin" of other competing standards such as HomeRF (which had strong Intel support).

➤ **802.11 was now The Wireless LAN standard in the market**

802.11 Wi-Fi Goes Home Apple Announcement 1999 \$99 NIC and \$299 Home Access Point

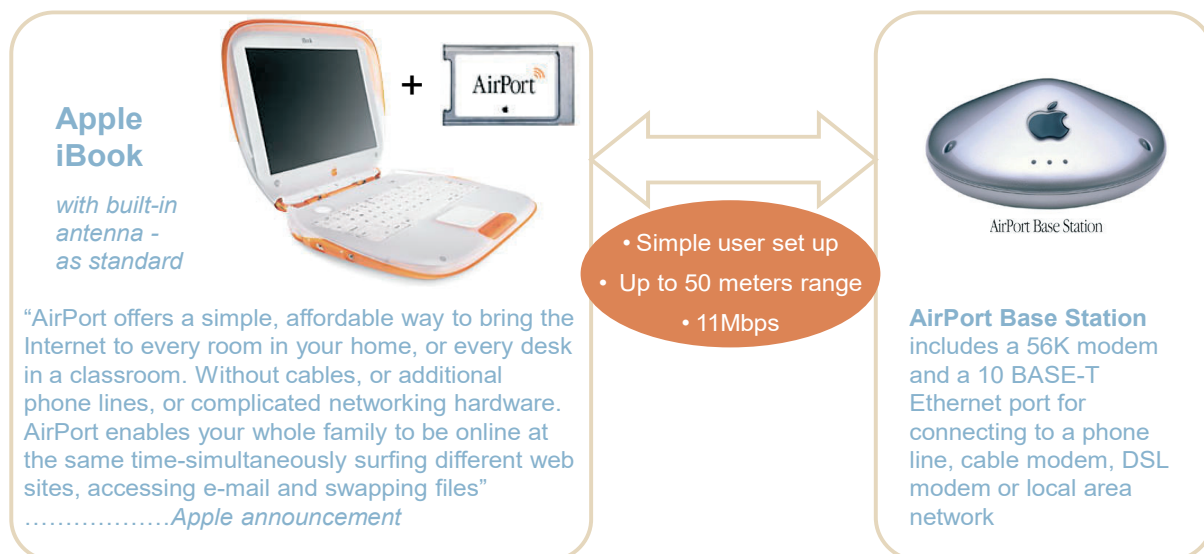

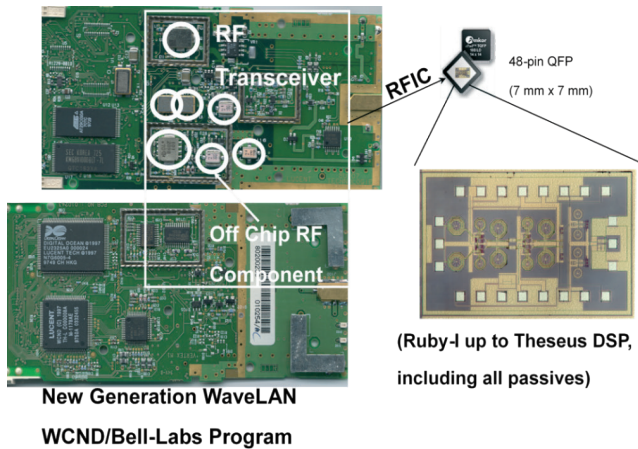

Further Radio Integration supported PCMCIA (credit card format) first released for Apple AirPort

Windows XP Wi-Fi goes native

The standard was ready with products and the price (shown by Apple) was what you would expect for a higher end networking card. All the other technologies either folded (HomeRF) or stayed directed on their main market (Bluetooth and handsets). Things started to move quickly.

One of the SW developers in Nieuwegein, Marc Meertens, was getting a lot of technical questions about our WaveLAN card SW from software developers at Microsoft in Seattle. There was an interest at the highest level in support Wireless LANs in their next OS release. I flew to Microsoft HQ and had a meeting with Jawad Khaki Corporate VP MicroSoft, in charge of Windows OS networking. We both had the same “passion” to do something new and our visions aligned perfectly, to get Wireless as part of Windows XP release. Until this next Microsoft release, the software we had to determine which Access Point to associate with and the “signal bar strength” level, was a separate installation as part of our WaveLAN product. Marc Meertens spent a year in Seattle supporting them in this further integration, which led to a native support of Wi-Fi cards in Windows XP in the 2001.

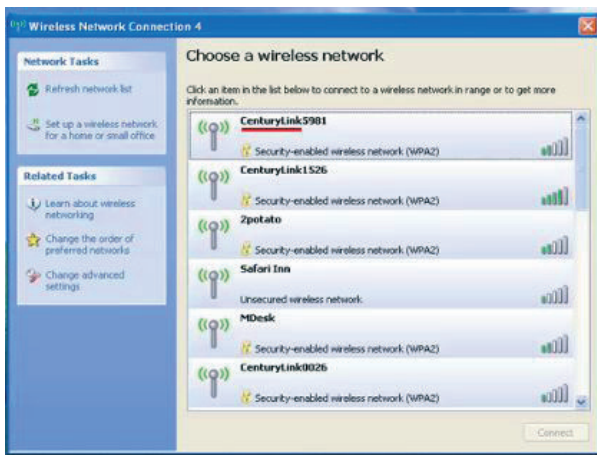

Now as most of the PC vendors came to the doorsteps of Nieuwegein and the swirl of the tornado started to be felt. Later in 2003 Intel launched their Centrino Platform and adopted Wi-Fi inside with wireless connectivity as the main theme. Wireless LAN and 802.11 was now ubiquitous and expected to be everywhere.

The continued journey

IEEE 802.11(a) OFDM 5GHz

At the same time the 802.11 (b) 11Mbps standard was being completed and product development (Apple) had another even higher speed 802.11(a) standard in the works in the 5GHz band and in the 54Mbps data rate! This was a proposal Lucent (Bell Labs³ Nieuwegein with Richard van Nee, leveraging the deep OFDM technology expertise within Bell Labs) and NTT. While ratified slightly earlier than the 11Mbps 802.11(b) standard, the technology was not yet ready for commercial deployment in a new 5GHz band so it did not yet get attention in 1999.

IEEE 802.11(g) OFDM 2.4GHz

Staying at 11Mbps was not an option, we needed to get higher speeds into the 802.11 standard (or others not part of the 802.11 technical community, would start propriety extensions with future compatibility issues).

While 54Mbps in the 5GHz band using 802.11(a) was a solution, the ecosystem was not ready yet for 5GHz solutions (2.4GHz antennas have been integrated, better range than 5GHz and cost targets all played a factor). Therefore, the same modulation technique used in this 5GHz standard was proposed in 2001 for the 2.4GHz band, which resulted in 802.11(g) (ratified in 2003).

Eventually with continued innovation (startups taking risks on CMOS radio integration for 5GHz), 802.11(a) would also be supported (with the advantage that the 54Mbps processing part is the same) allowing for a more optimized multi-standard interoperation in one chipset (802.11 abg).

- Orthogonal Frequency Division Multiplexing (OFDM) is a technique that divides a frequency band into a number of orthogonal (i.e., parallel) narrowband subchannels.



IEEE 802.11(n) MIMO

We knew from Bell Labs fundamental Research that much higher wireless speeds were possible without the need for more spectrum/bandwidth using multiple antennas and using the environments propagation characteristics to form separate spatially isolated channels. While the needed processing would be significant, signal processing capabilities and chip integration was moving the needle.

One aspect that helped facilitate this integration was the use of OFDM Modulation, since each narrowband channel sent did not suffer from reflections (echoes) requiring further complex processing (one of the reasons we pushed this technology for future migration). This lead eventually to 802.11(n) 2009 supporting data rates up to 600Mbps a factor 300X speed increase from the first IEEE 802.11 2Mbps standard! And this has not stopped since. With further expansion on MIMO and channel bandwidths 802.11(ac) breaking the 1Gbps barrier (2013) and continued innovative momentum today.

Conclusion

We started this without the foresight on how difficult new market and technology creation is. If we knew it then, it might have scared us away, but our young enthusiasm, coupled with the right timing, made it all work.

All involved in this journey have impacted the way we interact in the world today.

This was a life experience I am honored to have been part of.



Bruce Tuch

A “technical leader and innovator” of the first high speed wireless Local Area Network Product introduced in 1991 and a Co-Founder and contributor of the IEEE 802.11 standards group; the engine of broadband Wi-Fi technology. He is an industry leader who helped shape the wireless industry.

Bruce Tuch is the VP of Engineering at Vision Semantics Ltd., working on artificial intelligence products and deep learning neural networks, transforming the outcomes of vision analysis.

Previous roles:

VP of Development at PowerOasis, disruptive renewable energy and power management solution development. Including wireless base stations, solar power drones and solar powered cold chain.

Director of Engineering and Business Development at Filtronic plc a leading wireless radio backhaul supplier. At Motorola Bruce was the Sr. Director Global Business Development, CTO Ventures EMEA and M&A.

Within Lucent Technologies and Agere Systems: CTO Wireless Wi-Fi Division and Director of Engineering responsible for the total Wi-Fi product line development and Bell Labs team, with more than 25 years of industry experience in wireless telecommunications.

- How to beat Shannon! Gerard J. Foschini (autumn 1996). "Layered space-time architecture for wireless communications in a fading environment when using multi-element antennas". *Bell Labs Technical Journal* 1 (2): 41–59.

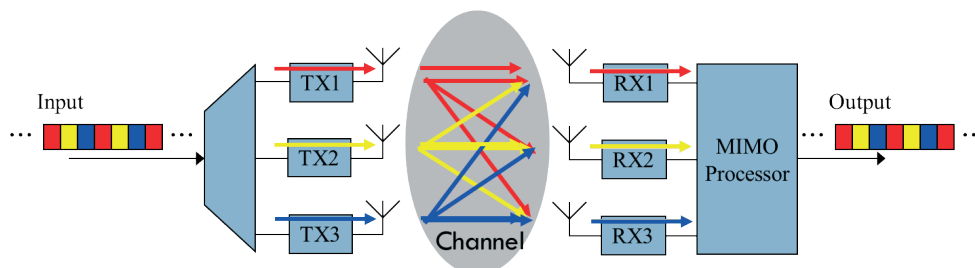

In general it can be shown that the throughput grows linearly with the number of transmit antennas!

³ Bell Labs AT&T in New Jersey agreed to set up a Research group close to a business doing groundbreaking products to facilitate technology transfer. I worked with Rich Gitlin (Bell Labs SVP Communications and Networking Research) as this was set up in Nieuwegein.

Insights on the First Years of IEEE 802.11

By Vic Hayes

Environment in the Beginning of the Work on WaveLAN

For understanding the situation of the WaveLAN team and the working group members in the early years, here is a description of the various aspects of life.

Communications

Wide Area Networks

The dominant use for data transmission was the Switched Telephone Network. It reached 10 kbit/s and increasing up to 64 kbit/s in 1998. Expensive leased lines were available at data rates of 1.5 Mbit/s in the U.S. and 2 Mbit/s in Europe. Mobile networks provided short message capability but did not carry data until 2000 with GPRS at 64 kbit/s.

Local Area Networks

In 1985 the first standard for a Local Area Network was published and was called IEEE 802.3. Physically, a yellow, stiff and thick coax cable was used for 10 Mbit/s over maximum 5 segments of maximum 100 m each, hence the name 10BASE5. The use of this standard was mainly for connecting mini computers, such as the PDP series manufactured by Digital.

In the final 1980's, NCR retail used a C255 LAN with 1,5 Mbit/s. AT&T had a LAN for 1 Mbit/s. Wireless LANs started in 1991 at 2 Mbit/s provided by WaveLAN.

Internet

Internet was already existent in 1987 but was mainly used between educational and military institutions before 1990.

E-mail

In first instance, Vic used a CompuServe account for communication. The first minutes of meeting of 802.4I or 802.11 only showed phone and fax numbers. The first e-mail addresses were shown in the minutes of the meeting of March 1991.

Vic's account was vic.hayes@utrecht.ncr.com.

Around July 1993 Digital Equipment Corporation

provided an e-mail distribution list for the working group members¹. As soon as the IEEE Standards Association's Office provided a distribution list, we moved to the IEEE Majordomo service in July 1995. The distribution lists were excellent means to manage the working group in a quick and efficient way.

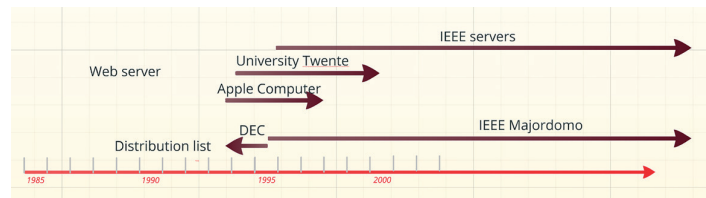

Internet usage at the IEEE 802.11 working group

Electronic document distribution

In May 1993, members of the working group from Apple Computer offered and installed a document server in Silicon Valley for efficient distribution of documents. It turned out that our members in Israel could not get files via the FTP service in Silicon Valley.

At the January 1994 meeting, a member and student at the University of Twente, the Netherlands, offered a mirror image of the server in Silicon Valley. A script synchronised the University of Twente server with the Apple server from midnight on².

At the end of 1995, the IEEE standards office offered a server at their office, which was adopted as the main document server for the working group.

Computer use

Desktop PCs were the predominant processors available in the office. Only few people had "lap"tops. Vic's laptop purchased in 1991 weighed 7 kg, including the adapter and the bag. It had a hard disk of 20 MB and a floppy disk drive for 1,4 MB floppies. The communication means was a 10 kbit/s modem.

¹ At that time we encountered a weak point in the system. Commercial e-mail providers like CompuServe and AT&T mail required that e-mails from one service to the other had to be delivered directly and had to be financially cleared. So, in our case an e-mail sent from a member at one service sent to the e-mail distribution list and then to another service was not delivered because the message was sent through Internet.

² At the end of 1996, Apple decommissioned their server. The result was that the script at the University of Twente synchronised at such a way that the Twente server was completely emptied. Thanks to an excellent back-up system the admin of the Twente University brought the server up within one hour!



Model: 316LT - Price: \$3499
 Released: November 6, 1989
 Weight: 15 lb. with Battery
 Processor: 16MHz 80386SX
 20MB HDD - 1.4MB floppy - 1MB RAM
 Internal modem & 640x480 mono display



The “luggable” PC used by Vic. This PC was carried as cabin luggage, 6 times a year across the world.

Software situation

Documents were made through various editors: Microsoft Word, WordPerfect, Wordstar and a mark-up language by IBM. Style sheets, separate files, handling of that time is now obsolete, so that it is impossible to recreate a nice document from the file archive. PDF were unknown. Copy and paste had to be done physically.

Thanks to the availability of the original documents and a sponsor, the documents could be digitized and under the control of Adrian Stephens, former chair of IEEE 802.11, the archive of dot 11 and dot4I from before 2000 was OCR’ed and are now available on the IEEE 802.11 document server.

Beamer emulation

From the beginning in 802.4I, the group used an LCD screen on top of an overhead projector to ensure that everyone could follow the work. Agenda, editing material, text of motions, etcetera were displayed and everyone was aware of the progress.

In later years, when the group grew in size above 50 persons, a high-power overhead was required. Beamers were made available by the Executive Committee later.



Using LCD on overhead projector

Document distribution between meetings Paper era

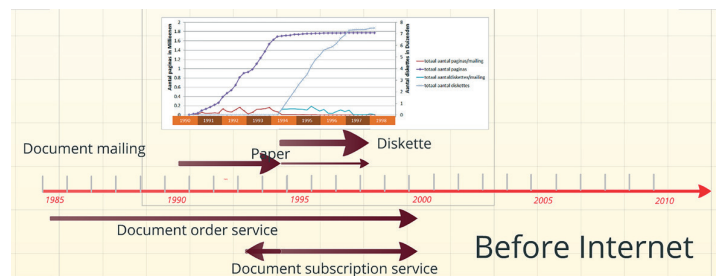

Situation of document distribution

Among members and oObservers

The working group is required to distribute all documents to the members and observers. Hence NCR had to send all documents to a distribution list that varied between 200 and 300 addresses. Close to two million pages were sent first class mail for within the U.S. and courier outside the US.

Floppy era

In 1994 the working group agreed to accept the document distribution via diskettes. There were still a few members that required paper distribution. Close to eight thousand diskettes were mailed and couriered. In 1998 the working group passed motion that distribution via mail and courier could be discontinued thanks to the availability of document servers.

Among the public

IEEE 802 had established a service that the public could order all submissions distributed to the members and observers through an Alphagraphics copy shop in Phoenix, Arizona.

To allow the public to better follow the work of our ambitious working group, I established a document subscription service. People could deposit a certain amount of dollars and the copy service would send them the packages immediately as long as their balance was adequate.

Document distribution during meetings

Paper rra and memory cards

In the beginning all information was exchanged on paper.

When memory cards became available, we attached helium balloons to two memory cards for circulation to the members, so that everybody knew where the memory cards could be found.

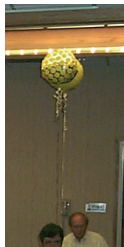

On our own product!

Finally, May 1998 we managed to use our own product to make the document distribution ideal. We obtained a laptop and loaded it with a server operating system and an FTP server. Through many links the server was made available to the members using both Frequency Hopping and Direct Sequence access points and PC Cards³.



Table with server and WLAN equipment

The standards making process

We started to work on an industry standard for Wireless LAN in 1988 on an existing taskgroup on the topic operating in IEEE 802.4, the Token Bus access method. After drawing the conclusion that Token Bus was not suited for Radio operation, we managed to found the working group for Wireless LANs, designated IEEE 802.11. Its first, interim, meeting was held in September 1990 at the GM plant in Oshawa, Canada. The first activities were defining terms and a study on the requirements. On the call for proposals we received 8 MAC proposals, 2 Direct Sequence proposals and 4 Frequency Hopping proposals.

In a selection process the proposals were withdrawn, merged or voted down. Eventually, the decision was that the MAC work was based on a joint proposal of NCR, Symbol Technologies and XIRCOM with support of National Semiconductor. The Direct Sequence PHY proposed by NCR was selected and the Frequency Hopping proposal proposed by CMI was selected.

Two groups were active on the PHY for radio. Frequency Hopping Spread Spectrum and Direct Sequence Spread Spectrum. Because 75 % support was required for technical decisions it was not possible to select one PHY. Hence both DS and FH are in the standard.

After the selection of the MAC and PHY components, a four year period of debates and developing the draft standard started, guided by a sequence of 4 working group letter ballots. August 1996 the sponsor ballot started, followed by a successful recirculation ballot so that the submission to the Standards Board for ratification was a fact on May 1997. In June 1997, the Board approved the standard and in November 1997 the base IEEE 802.11 standard was published.

All members with a sales organization encountered that the customers were reluctant to purchase a product with "only 2 Mbit/s" now that Ethernet provided 10 Mbit/s on unshielded twisted pairs and with projects on 100 Mbit/s on the way. So, we had an ambitious team, fully trained to make a standard.

Two projects were made: one project for higher data rates in the 5 GHz band (project name 802.11a) and another in the 2.4 GHz band (project name 802.11b).

Five proposals were received for 802.11a. Through the Bell Labs unit at the WCND facility, an Orthogonal Frequency Division Multiplexing (OFDM) proposal

³ During the May 1995 interim meeting, we deployed the first network with proprietary WLAN products

was submitted. NTT (Japan) also proposed OFDM and the companies agreed to merge their proposals. Two proposals were similar and were combined into one proposal, leaving the first ballot to three proposals. Out of the two remaining proposals, the Lucent Technologies and NTT proposal was selected and further developed to the standard.

Five proposals were received for 802.11b. WCND proposed an 8 Mbit/s scheme that they had just productised and placed on the market. This proposal fitted the U.S. rules for the spread spectrum modulation. However, Harris semiconductor had a proposal for 11 Mbit/s that used a loophole in the rules. The definition of the spreading was not defined. In the two first ballots, two proposals were removed. At the third ballot, the Lucent Technologies proposal was removed.

In the fourth proposal, the Harris proposal came to 48 % support against the other proposal reaching exactly 50 %, i.e. it did not reach majority and a heavy debate started with accusation of block voting. Having no time to work out the task group of 11b, the plenary meeting of the working group went through a heavy debate on how to proceed. The conclusion is captured in the following motion:

“To halt the current TGB voting process, to discard the result of the voting this week, to allow the presentation of merged proposals and to instruct TGB to find a consensus proposal.” Spicy detail: these votes and debates were held at the meeting in Utrecht, hosted by WCND in May 1998.

With the help of WCND’s Bell Labs expert in coding algorithms, Harris accepted cooperation into a joint proposal. At the July meeting the joint Harris/Lucent proposal was selected with 70 % support. Both 802.11a was published on December 30, 1999 and 802.11b on January 20, 2000.

In March 2000, my term of the office of IEEE 802.11 Chair ended and Stuart Kerry was elected for the responsibility of the working group. At the occasion I was pleasantly surprised with the presentation of the IEEE Leadership Award:

“For 10 years of Leadership and Extraordinary Dedication as Chairman of the IEEE 802.11 Wireless LAN Working Group”.

It was a challenging adventure to lead an organization of volunteers and arch-rivals. Many people assisted in making the success of the standards and its extensions within the market window.



Photo: © Roelof Pot, 2013

Vic Hayes

July 1974 Vic joined the Engineering Laboratory of NCR in Utrecht, the Netherlands, as Systems Engineer for specifying data communications protocols. Standards organisations were a good source of information.

Vic was one of the founders of the IEEE 802.11 Working Group for Wireless LANs in 1990. He chaired the group from its establishment until March 2000. As chair, he worked with European authorities to for the assignment of spectrum in the 2.4 GHz area and the 5 GHz area.

In March 2001 Vic founded and chaired the Regulatory Subcommittee within the Wi-Fi Alliance. This committee played a major role in the preparations of Resolution 229 at the World Radio Conference 2003, globally allocating 475 MHz of spectrum in the 5 GHz area for “Wireless Access Systems including Radio LANS” on a co-primary basis.

Vic retired from the Engineering Laboratory, then having the corporate name Agere Systems, on October 1st, 2003.

WaveLAN: Building the Foundation of a New Global Wireless LAN Utility, now known as Wi-Fi

By Dorothy Stanley

Congratulations to the WaveLAN team for their foundational work in developing the IEEE 802.11 Wireless LAN (WLAN) standard, and forming the Wireless Ethernet Compatibility Alliance, now known as the Wi-Fi Alliance®. Congratulations on developing the first mass market WLAN infrastructure modules and components, setting the foundation for the now nearly ubiquitous wireless LAN access technology which has become an expected infrastructure component of modern day life.

Books have been written to describe the ecosystem components necessary for growth of the WLAN market, technology has been and continues to be invented, protocols designed, technical standards and amendments debated, argued, and adopted. Chipsets and products have been designed, built, marketed now through six product generations in widespread use. I add my congratulations to all who worked in and led the WaveLAN organization over the years for their vision, perseverance, creativity and curiosity, bringing a new Wi-Fi communications infrastructure to the world.



Congratulations to Vic Hayes, pioneer, visionary, pragmatic standards developer and leader of the IEEE 802.11 Working Group from its inception to the year 2000.

In 1999, the IEEE 802.11 Working Group received PC Magazine's Technical Network Standards Category award of the year. This award marked the achieve-

ments of the first decade of work, presaging the developments and marketing success that would follow. Vic received the award on behalf of all who had contributed to the development of the standard.



The key question at the time was how to ensure that this new wireless LAN technology would "Cross the Chasm", moving from the early adopters, who were more than enthusiastic, to a larger market segment and then further to mass market adoption.

This question was answered when the WaveLAN organization (led by Cees Links, Angela Champness and Bruce Tuch) met the challenge set by Steve Jobs for a seemingly unachievable consumer product and price point, which would enable wireless networking in consumer applications. The visionary Apple AirPort product led to mass consumer market adoption of the IEEE 802.11 wireless LAN standard. Additionally, the need for industry interoperability led to the formation of the Wireless Ethernet Compatibility Alliance (WECA), quickly renamed to Wi-Fi Alliance, providing an easily understood and recognizable brand for the new interoperable wireless LAN technology and products.



Fast forward to 2019, Wi-Fi Alliance just released interoperability certification for Wi-Fi 6 (IEEE 802.11ax) supporting OFDMA and multi-gigabit per second data

Credit Wi-Fi Alliance, www.wi-fi.org/discover-wi-fi/20-years-of-wi-fi

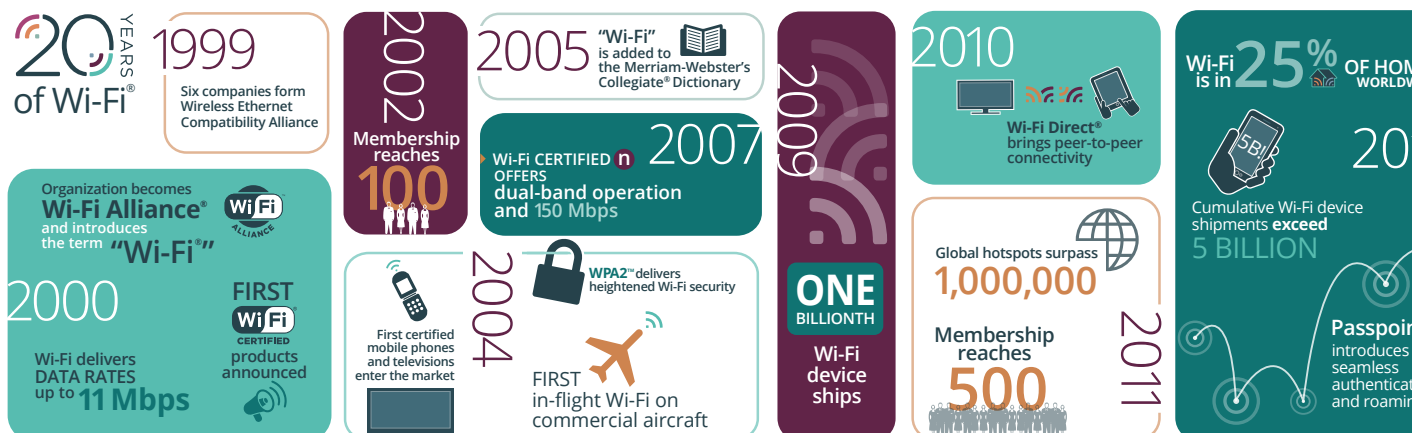

rates. From www.wi-fi.org/news-events/newsroom/wi-fi-certified-6-delivers-new-wi-fi-era:

“Wi-Fi CERTIFIED 6 is ushering in a new era of Wi-Fi, building on Wi-Fi’s core characteristics to provide better performance in every environment for users, greater network capacity for service providers to improve coverage for their customers, and new opportunities for advanced applications,” said Edgar Figueroa, president and CEO, Wi-Fi Alliance. “Wi-Fi CERTIFIED 6 will deliver improvements in connectivity, including in high density locations and IoT environments.”

Advanced capabilities available in Wi-Fi CERTIFIED 6 include:

- **Orthogonal frequency division multiple access (OFDMA):** effectively shares channels to increase network efficiency and lower latency for both uplink and downlink traffic in high demand environments
- **Multi-user multiple input multiple output (MU-MIMO):** allows more downlink data to be transferred at once and enables an access point to transmit data to a larger number of devices concurrently
- **160 MHz channels:** increases bandwidth to deliver greater performance with low latency
- **Target wake time (TWT):** significantly improves battery life in Wi-Fi devices, such as Internet of Things (IoT) devices
- **1024 quadrature amplitude modulation mode (1024-QAM):** increases throughput in Wi-Fi devices by encoding more data in the same amount of spectrum
- **Transmit beamforming:** enables higher data rates at a given range resulting in greater network capacity

The power of wireless networking is now in the hands of many more innovators than had previously been thought possible. Use of unlicensed spectrum together with affordable components and technology combine to enable innovative applications and products. Innovation continues with 802.11 wireless LAN technology being use not only for enterprise, consumer and operator applications, but also to connect the previously unconnected and for disaster recovery communications.

The graphic shown below, courtesy of Wi-Fi Alliance, depicts highlights of the growth of the WLAN industry over the last 20 years. This growth was enabled by the pioneering work of the WaveLAN team.

It has been my honor to have worked in and with the WaveLAN team and to be involved in IEEE 802.11 standards development for the last 20+ years. Congratulations to all WaveLAN team members on receipt of the IEEE Milestone award!



Dorothy Stanley

Dorothy Stanley is an HPE Fellow and head of standards strategy at Aruba, A Hewlett Packard Enterprise Company. She currently serves as Chair of the IEEE 802.11 Working Group.

She is also Chair of the IEEE 802.11REVmd Task Group. She has served in numerous leadership roles in Wi-Fi Alliance, and is co-chair of the IETF-IEEE 802 coordination committee.

Previous to joining Aruba Networks in 2005, Stanley was a Consulting Member of the Technical Staff at Agere Systems for Wavelan products and a Distinguished Member of the Technical Staff at Lucent Technologies and AT&T Bell Laboratories. Among Stanley’s awards are 5 patents, a WFA Members Achievement Award, and numerous IEEE Standards Association awards.

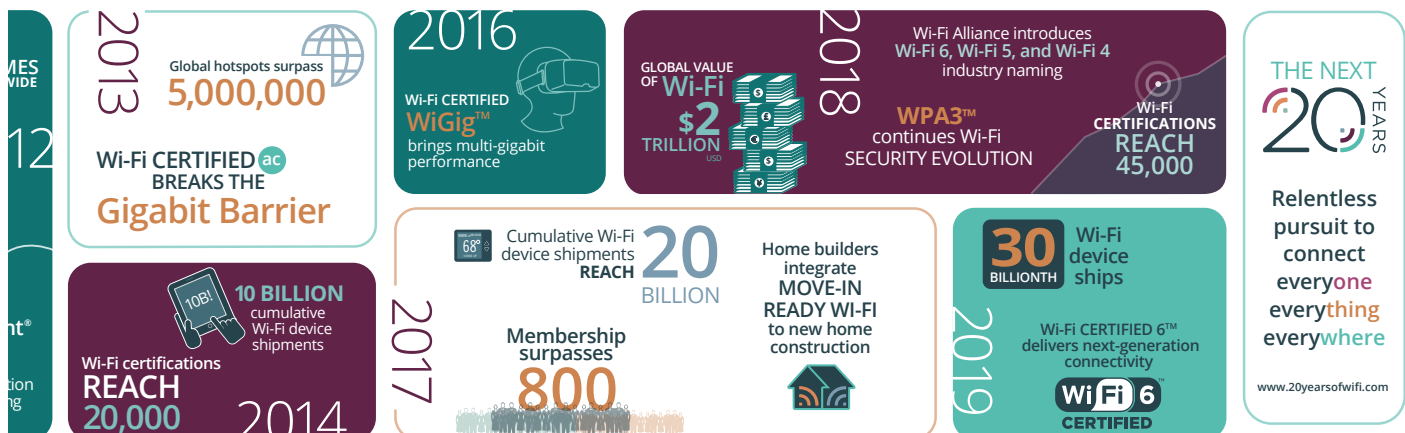

Crossing the Chasm into the Wi-Fi Tornado

By Angela Champness

I started working for the NCR Wireless Communications and Networking Division (WCND), or Systems Engineering Utrecht as it was called then, in September 1990, transferring from Canada where I was working for NCR. I was hired as a Product Manager, initially not for wireless but for software distribution. The organization was getting ready to launch the WaveLAN product at Network World when I arrived. A full-sized board to be inserted in desk-top PC's or Point-of-Sale terminals (us being NCR) for \$1390,00 a pop.

WaveLAN got instant attention. Data transmission over radio, how cool is that? It was easy to understand, sexy, it got lots of media attention, press briefings, meetings, demonstrations. It made a great story. But... it didn't sell. Everyone was interested in it, everyone wanted to see it working, as if they couldn't believe it really worked. But no one wanted to buy it. It took until 1999 and the launch of Apple with their version of the WaveLAN product called AirPort for WaveLAN to be successful. That was nine long years later...

Why did it take so long? The short answer is, we had yet to successfully "Cross the chasm". As Steve Jobs said "The Chasm is where many high-tech fortunes have been lost... the Tornado is where many have been made."

Geoffrey Moore's famous books helped provide answers and direction during those early years. What had we learned?

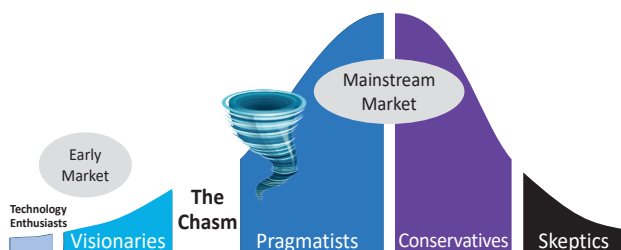

Geoffrey Moore's technology adoption life cycle

No doubt many of you will be familiar with the Technology Adoption Life Cycle. This cycle starts with the Technology Enthusiasts, they are the first to adopt new technology and they love fiddling and tinkering with it. These are your "techie". Most likely, most if not all of the WCND engineers are technology enthusiasts. Great guys, whom I worked with, with great pleasure for 15 years. But technolo-

gy enthusiasts make lousy customers because... they don't have any money. So these techies would beg, borrow or just maybe buy (or we would give), two WaveLAN cards. Only two. That's all they needed to test and tinker. But not enough to pay our salaries.

Then come the visionaries. These are the people who want to break with the past and use the new innovation to build a new future. These are the people that see "with their eyes closed" as Moore says. In other words, they can see what most of us cannot see – a new world with the new technology. Visionaries are the ones who bring real money to the table. However, they are demanding as customers.

Cees Links was our internal visionary at WCND. He was like an internal "customer" constantly demanding more from all of us. Though he did not directly bring money to the table as we were not a real "start-up" being part of NCR, he shielded the organization from the many reorganizations that threatened to dismantle the business. This is not to be underestimated. The business lost money from 1990 to 1995. From 1996 to 1998 we made \$30mil revenue per year and were about break even. Our revenue was flat, no growth. Keeping the business from being reorganized or dismantled by higher ups during those years was as important as the technology breakthroughs and standard developments. We were often involved in "executive reviews" or "quarterly presentations" where we had to convince our higher ups of the future value of WaveLAN so they wouldn't shut us down.

After the visionaries come the pragmatists, these are the people that make the bulk of the technology purchases. I am a pragmatist. We believe in evolution not revolution, to quote Moore. We want a proven track record, a cost benefit. We typically buy from market leaders as they are safe and secure. The product will work and there will be lots of third-party companies that support it.

But between the visionaries and the pragmatists is the now-famous "chasm" into which we fell. Visionaries make terrible references for pragmatists as pragmatists are worried, often correctly so, that the product will not fully 100% meet their requirements. They do not want to take the risk.

What was the problem with WaveLAN? Well, we made the classic mistake of thinking that the

product could be marketed horizontally. It is so sexy, it will just sell itself, right? But at \$1390, it was too expensive, at 2Mbps, too slow, being book size, too big and of course there was no standard for the mass market. WaveLAN needed to be marketed into specialty vertical markets that would benefit from the mobility that wireless would enable. But what was the problem with marketing into vertical markets? When you are in the chasm, you need to use what Moore calls the bowling pin strategy. You need to provide 100% of the solution for the vertical market you are trying to reach. If you only have 95% of the solution you still won't sell anything. For the customer (the pragmatist) to use your product, you need 100% of the solution.

So, what were we missing? Well, for one we had no access point. They hadn't been invented. You put the card into a server but that did not work to connect PC's or point-of-sale terminals to the corporate network or mainframe. Secondly, we had no roaming software. If you moved a point-of-sale terminal and it connected to another access point, it would need reconfiguration. Store personnel were not up to that. Thirdly the product only worked in the U.S. (915MHz). The 2.4GHz band was not yet available and was technically much more challenging. Fourthly we needed driver software for all different sorts of PC and network operating systems.

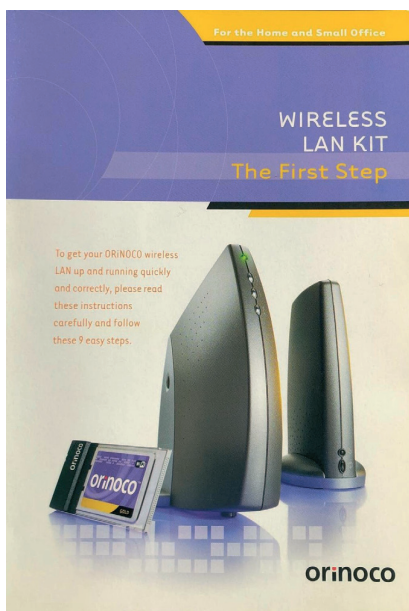

NCR was strong in the retail and banking industries so it should come as no surprise that our first large customers were a retailer (JC Penny) and a bank (Centura Bank). For JC Penny It was the ability to move the point-of-sale terminals to quickly redesign the shop floor that was the key selling point. Once we had the 2.4GHz technology, Japan and shortly thereafter Korea readily embraced the technology.

All early adopters. These were the key customers and regions who helped us to cross the chasm. They helped us to make a small profit, so we were no longer a financial drain on our larger mother company. This enabled us to convince our corporate NCR management in Dayton, Ohio and later when we were AT&T and Lucent in New Jersey that there was a future in this technology.

In 1999 we hit the tornado. The tornado is a period of mass market adoption when the market switches - all at once - to the new technology. This is when the pragmatists are buying en masse. We had recognized fairly early that WaveLAN could be sold as a component in the OEM market. Before we hit the tornado, we were very busy prospecting all the PC manufacturers of the time: Compaq, IBM, Dell, Gateway and of course Apple. We had meetings, discussions and then more meetings and discussions. And more. On and on. No one would bite. No one would take the risk. It took a visionary - Steve Jobs - to decide to take the risk.

I could write another article on how difficult it was to win Apple, but suffice it to say that once we won Apple, all, and I mean all (Compaq, Dell, IBM and Gateway) the PC vendors immediately called us and closed deals with us. I remember being at a Wi-Fi Alliance meeting in Hawaii (called WECA at the time for the Wireless Ethernet Compatibility Alliance) and all my competitors (Aironet/Cisco, 3Com, Nokia and Intersil) pounded me for information on how Apple could launch at a \$99 price. They were sure we were losing money. I never answered the question then, but I will do so now: it took a lot of work, but... we broke even.

There we were, in 1999, in the Tornado. We didn't know what hit us. We pretty much overnight, with the launch of Apple's AirPort using our product, became the gorilla of the then-fledgling wireless LAN industry. When a market moves into the tornado, it does so extremely rapidly and this happened to us. This is because pragmatists operate like herds, they don't want to be too early and incur the problems of premature adoption but also not too late to be at a competitive disadvantage. So all the PC vendors (the pragmatists) moved as a herd after Apple (the visionary) launched.

Our marketing strategy in the tornado was simple: just ship. During the tornado you actually reverse the marketing strategy of the previous phase. No bowling alley anymore where you segment vertical markets and work on 100% solutions. The focus is on supply and quality. In fact, you ignore the customer in the sense that you no longer do anything special or unique for a given customer. The demand is there, all you need to do is to supply.

As Moore says, in the tornado “Billions of dollars in company revenue appear from nowhere. They’re yours, and all you have to do is ship.”

Our revenue jumped from \$30mil to \$70mil in 1999, to \$230mil in 2000. The tornado is a wonderful time, right? On one hand it was. Everyone wanted to speak to us, to meet with us, to buy from us. But it was also a time of great chaos with many ups and downs. Customers were very demanding, even nasty because they needed to fight for their allocation. We were hiring frantically. We created the new position of program manager to manage the customers – or at least to be a buffer between the often angry customers if we could not ship enough – and our operations and quality engineers so they could do their job. We expanded our supply chain, distribution partners and sales force as rapidly as we could. This, combined with the fact that the company was reorganizing around us, made for an exciting but challenging time.

Would I do it again? Absolutely!



Angela Champness

Angela started working for NCR in 1987 in Canada and moved to the Netherlands in 1990 as a Product Manager. She was Product Manager for the first access point product called WavePOINT and roaming software called WaveNET. She then moved on to business development for WaveLAN in Asia. In 1996 she became Director of Product Management and Business Development and was a founding member and Secretary of the Wi-Fi Alliance.

In 2001 she became General Manager of the ORINOCO division which she sold to Proxim Corporation in 2002. From 2003 to 2006 she was Chairman and CEO of Radio in Finland and in 2006, after selling Radionet to Airspan, she made a career switch to the corporate wellness business and started her own company MyDailyLifestyle where she continues to work as Managing Director.

Wi-Fi Now and Future

By Claus Hetting

Yes it’s true, 2019 marks the 20-year anniversary of world’s most popular wireless technology. And Wi-Fi NOW is celebrating this at events and all through the year with interviews and blogs about many of the great people who made it happen.



The year 1999: how it all began

If you’re like me and if you’ve been around for a while you may remember some of the things that happened in 1999: the Euro common currency was born. President Bill Clinton was acquitted by the U.S. Senate. Spongebob Squarepants premiered on Nickelodeon TV. Vladimir Putin took over from Boris Yeltsin and became president of Russia.

But 1999 was also the year when Wi-Fi was born. Yes, Wi-Fi industry stalwarts will argue ad infinitum about the sequence of events and what caused what but here is what we believe: In 1998 – after WLAN had been technically and commercially verified by early pioneers – Steve Jobs hired Lucent to develop mass-market WLAN technology. In summer of 1999 Apple launched the world’s first laptop computer with built-in Wi-Fi (the Apple iBook) and the first consumer-grade Wi-Fi router (the Apple AirPort).





The Wi-Fi Alliance is formed

From then on laptops with built-in WLAN quickly became what everyone wanted. In 1999 the precursor to the Wi-Fi Alliance was formed in order that the explosion of new WLAN devices be certified for interoperability. The organisation chose the less than catchy Wireless Ethernet Compatibility Alliance or WECA as their name. In year 2000 the name was officially changed to the Wi-Fi Alliance and henceforth – in one fell swoop – WLAN became Wi-Fi.

We arguably also owe much of incredible success of Wi-Fi to the introduction of the iPhone in 2007 and the unprecedented acceleration of wireless innovation that followed. Today Wi-Fi carries well over 80% of smartphone traffic in many countries. The global economic surplus value of Wi-Fi has been estimated to a staggering \$1.96 trillion U.S. dollars. And at some point in time during 2019 Planet Earth will become home to more than 10 billion Wi-Fi connected devices.

A heartfelt thanks to the industry giants

We have a lot of great folks to be thankful for when looking back. In 1985 Dr Michael Marcus was instrumental in making the first (2.4 GHz) bands available for spread spectrum use. And without the tireless efforts of Vic Hayes – known as ‘the father of Wi-Fi’ – as founder and first chairman of the 802.11 working group there would likely be no Wi-Fi today at all.

We’re also enormously thankful for the work and leadership of Wi-Fi Alliance President & CEO Edgar Figueroa who has guided the Wi-Fi industry into a golden age of accelerated growth and innovation. And this of course is only a select few on a long list of great Wi-Fi people of past and present – many of whom are still contributing to the continued evolution and success of Wi-Fi.

The Wi-Fi future looks more than promising

But we also have to look ahead – and in truth there’s a lot to look forward to. For the first time in more than a decade Wi-Fi is on track to get more spec-

trum to work with. Possibly up to 1.2 GHz more Wi-Fi spectrum could be released in the U.S. by end of 2019. And there is more: the much-discussed 5.9 GHz band – which straddles the existing 5 GHz and future 6 GHz bands – may also become available to Wi-Fi following the reopening of this case by the FCC earlier this year.

We’re also tantalisingly close to the launch of a brand new and vastly better version of Wi-Fi. Past standards have improved the lives of billions of people and Wi-Fi 6 is on track to do exactly that, except even more so. Optimised to deliver more of what you want, to more devices, more reliably, than ever before, Wi-Fi 6 is a leap towards more and higher-quality connectivity everywhere. And don’t forget: Wi-Fi 6 is very much about connecting things, too.



Let the innovation begin!

As with all previous versions of Wi-Fi the recipe for success is simple: get the technology out there and let innovation reign. ‘Wi-Fi is innovation without a license,’ said FCC Commissioner Jessica Rosenworcel. And she’s right. After the first twenty years of uninterrupted global success, there still is no wireless technology quite like it.



Claus Hetting

Claus Hetting is the CEO and Chairman of Wi-Fi NOW, the world’s only media and advisory organisation dedicated to the global Wi-Fi industry. Claus has a background in engineering and has worked for close to 25 years in the IT and telecoms industries including 8 years at Nokia Networks and many subsequent years as an independent technology consultant. Claus is a graduate of the London School of Journalism and is widely recognised as an international thought leader in telecoms and wireless technology.

Importance of the IEEE Milestone Program

By José M. F. Moura, IEEE President and CEO

Thank you all for attending and being a part of this very special IEEE Milestone dedication, commemorating the development of WaveLAN technology, which led to formation of the IEEE 802.11 Working Group for Wireless Local Area Networks and the establishment of the now omnipresent Wi-Fi industry.

For those who are unfamiliar with IEEE, we are the world's largest technical professional society. IEEE's core purpose is to foster technological innovation and excellence for the benefit of humanity. Our more than 422,000 members are vibrant, diverse engineering and technological professionals who are committed to elevating their professional image, expanding their global network, connecting with peers locally, and giving back to their community. This global membership is the heart of IEEE. In more than 160 countries around the world, IEEE members see each other as part of an international professional community. This global network provides unique opportunities for our members to connect with technical experts conducting cutting-edge research around the world and shape technical standards with international reach.

Standards drive the functionality, capabilities and interoperability of a wide range of products and services that transform the way people live, work, and communicate. As one of the leading producers of standards in the world, IEEE has been committed to their development for over a century, for we believe that innovation can - and should - happen anywhere.

As innovation is the catalyst for technological advancement, standards are the catalysts that enable this innovation. Standards provide the framework for a globally level playing field. Internationally recognized standards enable researchers in Benelux to work with their counterparts in Portugal to advance technology, they provide a common ground for companies in India and the U.S. to work together on product development.

Today we recognize and commend the tremendous Dutch engineers who demonstrated a method for significantly increasing the data rate achievable under new regulations that permitted license-exempt short-range wireless data communications in certain frequency bands.

Dedicating an IEEE Milestone takes tremendous effort and the members of the IEEE Benelux Section are commended for their generous gifts of time, energy and expertise in making this milestone a reality. I want to thank Wim van Etten, Chair for Life Member Affinity Group, for his invitation to participate.

The IEEE Milestone program honors significant technical achievements in electrical, electronic, and computer engineering and the associated sciences. Funded by donations to the IEEE Foundation and administered by our History Center, the program recognizes great moments throughout our world's long history of technical innovation.

The program began in 1983, as part of IEEE's Centennial Celebration. Today's milestone is our 204th worldwide, the 49th for Region 8, and the 3rd for the IEEE Benelux Section. Three centuries of technological progress are now marked by IEEE milestones.

Chronologically, they start with Benjamin Franklin's electrical research and experimentations conducted in London and Alessandro Volta's invention of the electric battery in 18th century Italy. They continue with landmarks of the 19th century — such as the demonstration of practical telegraphy by Pavel Shilling and Samuel Morse; the first applied system for using alternating electrical current; and Aleksandr Popov's early contributions to wireless communications. IEEE milestones also recognize 20th century accomplishments, such as the pioneering commercial radio broadcasts of Westinghouse Radio Station (November 1920, KDKA in Pittsburgh, PA, USA); the invention of the first wearable cardiac pacemaker; and the discovery of superconductivity in 1911 at Leiden University.

Today, we have the wonderful opportunity to commemorate a major milestone on technology's path of progress, one that defines the 21st century.

IEEE Milestones help to increase the public's understanding of the contributions to society made by electrical, electronics, and computer engineers, and the strides made by countless technologists as they sought to advance technology to benefit humanity.

Milestones are also a way for members in IEEE Sections to take pride in their profession and its accomplishments. They demonstrate to their local community how engineers, scientists, and technologists have contributed not only to that community, but also to our global community, helping to build today's technologically advanced world.

IEEE Milestones are a symbol of how electrical engineering and computing have helped to build the modern world and bring people closer together.

It is my privilege to recognize these pioneering events, and the people behind them. They serve as landmarks in the progress of technology and in the progress of civilization.

I am honored to be a part of this celebration.

WaveLAN to Wi-Fi®: Wireless Connectivity Nurtured by Many Becomes an Essential Part of Daily Life

By Edgar Figueroa

As the world celebrates twenty years of Wi-Fi®, we honor and acknowledge the team that laid part of the foundation to this great technological advancement. Wi-Fi has grown from an idea - a confoundingly, seemingly impossible idea - to the world's most used communications technology, expected to contribute nearly \$4 trillion USD in economic value by 2023¹. Nearly every mobile device on the planet ships with Wi-Fi, and more than half of all internet traffic traverses Wi-Fi networks². The foundation laid by this group of honorees has become one of the greatest technological phenomenons of all time.

When I think about the humble beginnings of Wi-Fi, a passage from Theodore Roosevelt's speech given at the Sorbonne in 1910³ comes to mind: "...credit belongs to the [person] who is actually in the arena... who **strives valiantly**; who errs and comes short again and again; who knows the great enthusiasms, the great devotions, and spends himself in a worthy cause; who, if he wins, knows the triumph of high achievement; and who, if he fails, at least fails while **daring greatly**..."

The work done by the WaveLAN team - and other early industry leaders - leading to the establishment of the IEEE 802.11 working group qualifies as daring greatly. They devoted themselves to an idea, a spark. Their dedication to the idea of wireless connectivity and their commitment to persevere, to iterate, to try again and again, has given the world a great gift. Everyone involved in that group, and those who came after to shepherd this nascent technology into the essential service it is today, should take pride in their contribution to society - a contribution that, like Roosevelt's famous quote, is now part of

world history. You brought something to the world that brings terrific value, and your legacy of daring greatly continues to this day.

When WaveLAN first went to market, it was part of a proprietary solution which was licensed to a handful of companies, including founding Wi-Fi Alliance® member, Lucent Technologies. Once introduced into the IEEE family, other products based on the 802.11 standard began to enter the market, and the precursor to what we all know as Wi-Fi was born.

Just a couple of years later, IEEE 802.11b was ratified, offering a maximum data rate of 11 megabits per second (Mbps) – considered suitable performance to deliver the WLAN experience. It was around this time that Wi-Fi Alliance® was established to ensure that the further development of this technology included interoperability across brands and technical protocols – the last frontier to unleash the potential for this promising harmonized technology.



Nurturing Wi-Fi for continued success

The foundation of Wi-Fi is rooted in its unique, inherent strengths: affordable performance, unlicensed spectrum operation, easy deployment, and



long-term compatibility. These strengths all contribute to Wi-Fi success. But there is more to Wi-Fi than this. Wi-Fi Alliance, with more than 800 member companies worldwide, has helped the industry nurture this technological innovation for twenty years. Moving beyond connectivity, Wi-Fi Alliance has evolved its shepherding of this technology with certification programs that deliver on the original promise of Wi-Fi, while also providing easier access, enabling enhanced Wi-Fi applications and services, and designing optimizations that make Wi-Fi so important to the world today. Wi-Fi CERTIFIED™ programs developed within Wi-Fi Alliance combine the use of IEEE standards and in-house development of technologies to create industry-wide solutions that support an expanding array of devices and uses.



The Wi-Fi Alliance portfolio of programs bring full coverage Wi-Fi indoors (Wi-Fi CERTIFIED EasyMesh™, Wi-Fi CERTIFIED Home Design™), help improve connectivity and mobility outside the home (Wi-Fi CERTIFIED Passpoint® and Wi-Fi CERTIFIED Vantage™), make Wi-Fi networks operate more efficiently and easier to manage (Wi-Fi CERTIFIED Easy Connect™, Wi-Fi CERTIFIED Agile Multiband™, Wi-Fi CERTIFIED Data Elements™), and enable an array of applications and services that enhance connected life for users (Wi-Fi CERTIFIED Wi-Fi Aware™, Wi-Fi CERTIFIED Location™, Wi-Fi CERTIFIED Miracast®). Consumers who purchase Wi-Fi CERTIFIED products can have confidence that their product will deliver a good user experience.

In addition to certification programs and technology development, Wi-Fi Alliance drives spectrum advocacy globally. The industry has done an incredible job of improving Wi-Fi while using spectrum allocations that originated 30 years ago – serving an installed base of nearly 14 billion devices⁴. But Wi-Fi demand has grown so much that Wi-Fi Alliance is urging regulatory agencies worldwide to allow more spectrum for Wi-Fi so that Wi-Fi benefits and experience can continue into the foreseeable future.

Wi-Fi now, and in the future

Without WaveLAN, then 802.11, and ultimately Wi-Fi, our society would not have the opportuni-

ties it has today. Wi-Fi has emerged as a valuable key to untethered, affordable connectivity and wide-ranging innovation. Operating in unlicensed spectrum, Wi-Fi is an equalizer, enabling even the smallest of startups to innovate and change the world. Wi-Fi has exceeded our wildest dreams, and today many believe Wi-Fi is essential to running our societal institutions. From hospitals to schools, from utilities to governments, from financial institutions to cloud services, our modern world runs on Wi-Fi connectivity.

Today, Wi-Fi 6 is capable of multi-gigabit speeds at longer distances for a multitude of devices within a single network. The current generation of Wi-Fi goes beyond simply connecting devices—it enables people far and wide to communicate: from lightweight text, to latency sensitive voice, to rich real-time ultra high-definition video. Wi-Fi delivers essential communications to the world every second of every day. Its affordability renders communications across technologies other than Wi-Fi also more affordable. Wi-Fi helps people and businesses manage and protect their homes and offices. It has been the platform to transform content delivery, from streaming live video broadcasts, to movies and music services, to interactive gaming. Wi-Fi has become a valuable resource in disaster recovery and public safety, and is a key enabler of bringing broadband to remote communities and bridging the digital divide. Wi-Fi is now used in the most isolated places on the planet, from Mount Everest and aircraft carriers in the middle of the ocean to the great beyond, by astronauts at the International Space Station.



¹ Telecom Advisory Services, 2018

² Cisco VNI, 2019

³ "Citizenship in a Republic", Theodore Roosevelt, Paris, 1910

⁴ IDC, 2019

Our community's Wi-Fi development and constant innovation has delivered capabilities that twenty years ago we would never have believed possible. The industry is clearly committed to continue the trajectory we have been on to constantly enhance and improve what Wi-Fi can do. Emerging applications for Wi-Fi include artificial intelligence and augmented and virtual reality uses that enable doctors to see patients remotely, predictively manage automotive and aviation traffic, and enhance agricultural yields, among many, many other emerging uses. Opportunities in the 6 GHz band with its larger channels will be key to advancing even more bandwidth-intensive applications. There is no limit to the good we can do as a society using Wi-Fi to its full potential.

Continuing the tradition of daring greatly

Many believe that the continued growth and success of Wi-Fi comes down to the industry's commitment to ensure that the technology can be integrated and offered by a wide array of products, representing a vibrant ecosystem with countless use cases. Besides the great strides and technological innovation Wi-Fi has seen the past twenty years, let us recognize that it would not be as ubiquitous as it is without the industry's foresight and dedication to industry-agreed standards that work everywhere the same way, regardless of vendor.

As with most success stories, there are roadblocks along the way. Over the past decades there have been series of events that, at any given point, could have halted Wi-Fi progress. At every such instance we as an industry galvanized, and we dared, and we met our challenge. There are countless people around the world who have dedicated their lives to continuing the great tradition started by the WaveLAN team so long ago. A whole army of individuals at every phase of Wi-Fi growth and development has contributed to its success. Our industry will continue to nurture this technology through leadership, innovation and cooperation in relentless pursuit of our Wi-Fi Alliance vision to connect everyone and everything everywhere.



Edgar Figueroa

President and Chief Executive Officer
Wi-Fi Alliance

Since 2007, Edgar has led a period of extraordinary growth in Wi-Fi and Wi-Fi Alliance by focusing on three key areas: membership, certification, and advocacy. He established consensus agreements and strategic alliances across industries, engaged with policy and legislative agencies worldwide, and spearheaded acquisitions, mergers and spin offs to ensure continued Wi-Fi proliferation into mass markets such as consumer electronics and mobile. Edgar also forged Wi-Fi Alliance expansion in Asia and Europe. Before his current role, Edgar oversaw Wi-Fi Alliance technical operations, defining the industry's original program development framework and globally scaling Wi-Fi certification.

Prior to Wi-Fi Alliance, Edgar was at Ridgeway Systems (now Cisco) on the team that delivered the world's first session border controller with essential technology for live Internet voice and video communications that became an international standard. Edgar also held product management and engineering roles at 3M Company. He is a veteran of the United States Navy, and a graduate of the University of Texas at Austin. Edgar holds a Master's degree in Technology Commercialization, and undergraduate degrees in Mechanical Engineering and Mathematics. Edgar also graduated from Kellogg's Executive Scholar program.

We Are Qorvo

Core RF Solutions



Your Smart Partner for the World's Toughest RF Challenges

Qorvo brings unique expertise in core RF networks, from Wi-Fi to Gigabit LTE and 5G, to the IoT and other emerging applications that connect people, places and things. Qorvo technology and products enable global connections with more data capacity and always-on reliability. Whether for mobile devices, smart home applications, communications infrastructure or defense systems, Qorvo has top design, manufacturing, applications engineering and global resources to serve the world's leading customers.

Key Applications

Automotive | Cellular and 5G Networks | CATV Networks | Customer Premise Equipment (Wi-Fi Access Points & Smart Meters) | Defense & Aerospace | Gateways/Set-Top Boxes | IoT (Internet of Things) | Mobile Devices | NB-IoT | Radar | Satellites

Key Products

Amplifiers | Antenna Control Solutions | Communication SoCs (Systems on a Chip) | Control Products | Discrete Components | Filters & Duplexers | Frequency Converters | Integrated Modules | Wi-Fi Solutions | Multiplexers | Oscillators | RF Fusion™ & RF Flex™ Solutions | Switches | Transistors & ICs

Qorvo's Brand Promise



Innovation

30-plus years pioneering the advanced solutions of tomorrow



Product Leadership

Design and build high-value RF solutions to stringent customer demands



Speed

Trusted supplier solving customers' toughest RF challenges quickly



Scale

Support large customers with high-volume manufacturing expertise

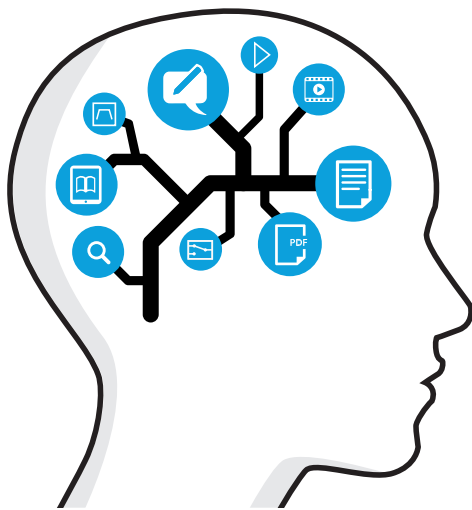

Feed Your Genius

Explore our resources to find out how with design tools, videos, whitepapers, ebooks, block diagrams and more.

www.qorvo.com/designhub

QORVO®

QORVO, RF FUSION and RF FLEX are registered trademarks of Qorvo US, Inc. in the U.S. and in other countries. | ©2019 Qorvo US, Inc.

Wi-Fi - Making the Difference

By Cees Links

This year, 2019 is a special year – celebrating 20 years Wi-Fi, and the market launch of the Apple iBook with wireless LAN included, without doubt, the breakthrough in the market. In the same year that the IEEE bestowed the NCR team in Nieuwegein with the technology breakthrough award for WaveLAN. And for me personally, to receive the lifetime achievement award from Wi-Fi NOW, for all industry contributions to Wi-Fi over the last 30 years since 1989.

Looking back, after rereading my own book, I can only do this thankfully and with a certain degree of amusement. How the first 10 years were a struggle. How people kept on believing that there was something cool about what was going to be Wi-Fi, but at the same time, about all the times that we had to make a “return on investment calculation” on the benefits of Wi-Fi. How Wi-Fi moved from a “nice-to-have” feature into a “basic requirement” today.



From a personal level I would say: if you would have known everything in advance, would you have gone on this journey? Honestly speaking? Probably not. The challenges and objections caused a lot of agony and pain. But at the same time. Looking back, I realize that it was more than worth it. What can an engineer expect as a greater reward than the success of the product in the market? I am sure I am saying this on behalf of everyone who participated in this.

My 18 years old son has never lived without Wi-Fi, interestingly: Wi-Fi is considered synonymous for “internet access”. When he has friends coming over: the first request is always to get the Wi-Fi password, as for the young generation, connectivity is the first thing that comes to their mind. If I try to explain to him how difficult it was to get the Wi-Fi concept “sold”, he is just confused: something does not add up. And frankly speaking it does not.

Or maybe it does? Wi-Fi was just waiting for the applications becoming available that would be recognized as valuable. Wi-Fi was just waiting for the new generation of applications that would leverage

continuous connectivity. The applications in the last decade of the previous century were satisfied with casual connectivity. Downloading was the key word. This all has changed now. Downloading has been replaced with continuous connectivity.

In 2016 I attended a conference in Washington, where a speaker from the FCC expressed his amazement about how homogeneous Wi-Fi is worldwide compared to 3G, LTE(4G) and 5G. He received a copy of my book, giving him the background, of how this all came together. In this respect it is good to mention that the FCC in the USA, always had a sort of mindset to match making frequency bands available in the unlicensed space in equal amounts as was licensed. So, when the amount of licensed spectrum was extended for cellular networks, the amount of unlicensed spectrum was extended as well.

I will not go into the billions of dollars of economic value created by Wi-Fi in the unlicensed band. These numbers are highly speculative. That about 65% of the internet traffic goes over Wi-Fi, and 35% goes over the cellular network, is telling enough. Of course, sooner or later all wireless communication ends up on a wire, but the freedom, the constant connectivity anywhere and at any moment is the beauty for which wireless is so highly recognized.

A lot has happened in the 20 years of world Wi-Fi market adoption. Already in the early days Wi-Fi was under serious attack from both 3G and Bluetooth – both planning to make Wi-Fi redundant and eliminate it, not successfully so. There maybe a deeper reason why on the contrary, Wi-Fi, Bluetooth and cellular all three made it to our smart phone. Each of the three technologies represent how we experience life in the physical world.

Wi-Fi is the technology for our dwelling places: our homes or our offices. It is as if we own the spectrum in our dwelling places, and it is available licensed free. Bluetooth is the technology for our personal bubble: when we go around, we bring our headset, or our fitness band, that stay in continuous contact with our phone. It feels also as if we own the spectrum in our personal bubble. And then there is our “outdoor” connectivity, where a third party is providing connectivity, and for which we sign up

and receive a token, called a SIM-card. Without this being planned this way, it seems to make sense, and in a way, it all worked out.



What still amazes me by the day of today is how “alive and kicking” Wi-Fi is. While in 2019 being in the middle of the launch of Wi-Fi 6, the data rate has reached a factor 1000 up from the product that we released with Apple in 1999. There is something funny about Wi-Fi-6, and it shows how marketing works. The reason for the number 6 is just to be “one up” compared to 5G. The reality is that Wi-Fi 6 is actually the seventh IEEE standard, after 802.11, 802.11a, 802.11b, 802.11g, 802.11n, 802.11ac, and now 802.11ax – but who cares: only few people know and keep track!

What is clear is that there always has been some (healthy?) rivalry between Wi-Fi on one side and the cellular standards: 3G, LTE(4G) and now 5G on the other side. Personally, I have always found the train an interesting location in this respect. Is the train a



hotspot, like a store, or a café? Or is the train a mobile environment? It looks like the latter is winning, and most people are satisfied

with their 4G connection in the train – or very dissatisfied with the performance of the Wi-Fi internet access in the train?

The last 20 years also saw the emergence of the IoT, with the requirement for a low power standard.

Appetite for Speed

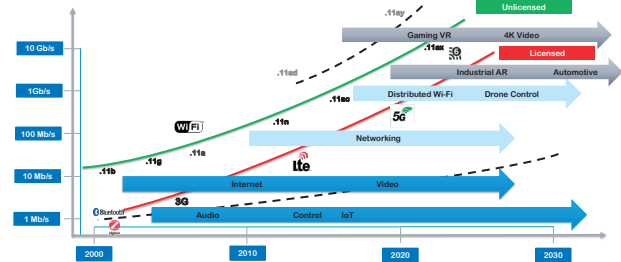

The WaveLAN team - photo made on 26 June, 1998 in Doorwerth, the Netherlands



Bluetooth saw the emergence of Bluetooth Low Energy (BLE), and Wi-Fi saw the emergence of Zigbee or Thread (actually the emergence of IEEE 802.15.4). Market dynamics have not brought Zigbee/Thread and Wi-Fi close together, but with the distributed architecture of Wi-Fi 6, there is a new chance, the future will tell.

It is clear that the original Wi-Fi standard and the market breakthrough in 1999 was not the end of the development. It was more the start of a very dynamic period, that has not come to a closure yet. With the recent notice by the FCC for allocating more bandwidth for Wi-Fi in the 6 GHz, in particular, higher capacity for Wi-Fi is becoming possible: providing more users simultaneously with higher bandwidth. With the standard developments in the 60 GHz under what was known as WiGig (.11ad and .11ay), but which is now part of Wi-Fi, there are even more opportunities for capacity increases.

Yes, Wi-Fi is alive and kicking and I would like to commend the standard and everyone who participated and still participates on its further developments with the success that has come out of it. When we started the Wi-Fi journey, we had the impression we were onto something interesting that probably would build good products. We had no idea how pervasive Wi-Fi would become, and we can just be genuinely and honestly amazed about it.

It was a long journey, more than 30 years long. But from my perspective: the results definitely made it worth its while.

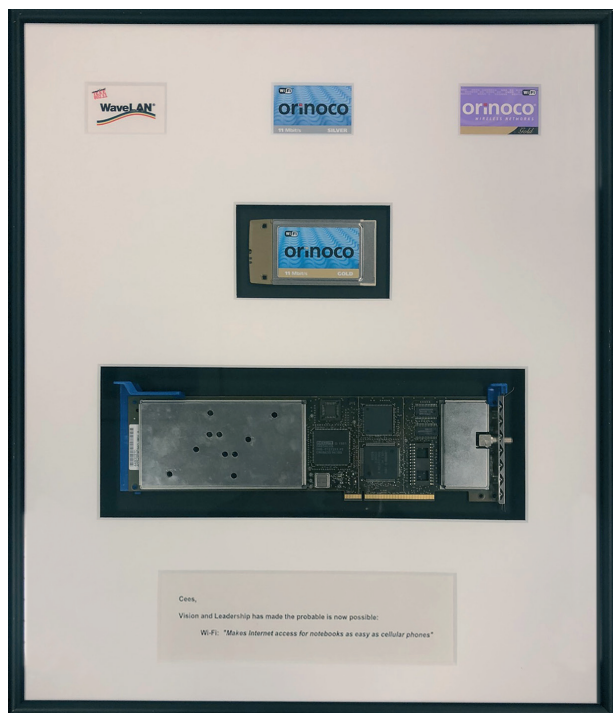

Early WaveLAN Products: including a full-size microchannel-card as well as PCMCIA-cards



Cees Links

Cees Links is a Wi-Fi pioneer. Under his leadership, when he worked for NCR, AT&T and Lucent Technologies, the first wireless LANs were developed - ultimately becoming household technology integrated into phones, tablets, laptops and many other devices around the world. He also pioneered the development of access points, home networking routers and hotspots.

He was involved in the establishment of the IEEE 802.11 standardization committee and the Wi-Fi Alliance. He was also instrumental in establishing the IEEE 802.15 standardization committee as the basis for the Zigbee sense-and-control networking.

Cees was the founder and CEO of GreenPeak Technologies, now part of Qorvo, and currently serves as the General Manager of the Wireless Connectivity Business Unit.

In 2017, Cees received the Golden Mousetrap Lifetime Achievement Award, and he was inducted into the Wi-Fi NOW Hall of Fame in 2019.

IEEE at a Glance

by Wim van Etten

IEEE worldwide

With more than 422,000 members, IEEE is the largest technical professional organization. It is dedicated to *Advancing Technology for the Benefit of Humanity*. The long name of the organization is *Institute of Electrical and Electronics Engineers*.

The IEEE was established in 1963 as a merger of two institutes of electrical engineers. The first one is the AIEE (American Institute of Electrical Engineers). This organization was erected in 1884 and quite a few famous electrical engineers chaired it, such as Edison, Bell and Tesla. The second merging institute was the IRE (Institute of Radio Engineers), which was erected in 1912. It was chaired by famous engineers as well, to mention: Lee de Forest, Terman and Hewlett. As the name suggests the AIEE was mainly focused to U.S. membership, whereas the IRE was more worldwide organized. By this merger a very powerful and worldwide institute arose.

In order to administrate this worldwide large institute efficiently it is divided in geographical regions

- Region 1 to Region 6: US
- Region 7: Canada
- Region 8: Europe, Iceland, Greenland, Russia, Middle East and Africa
- Region 9: South America
- Region 10: Far East

It will be clear that Region 8 is by far the most extensive region from a geographical point of view. However, this is not the case as to membership. This is obvious when you take in mind that it comprises many developing countries and sparsely populated countries as Iceland and Greenland.

Apart from this geographical grouping there are a few more organizational units defined:

Region: organizational unit that represents IEEE in territory

Section: organizational unit that covers part of a region (one or a few countries)

Society: community for exchange of technical information among members in a specific discipline

Chapter: technical subunit of region or section

Student branch: organizational unit of student members from a particular college, university or technical institute

The Chapters are centered around a technical area of interest (in accordance with one or a few Societies) and Student Branches by geographic location. They organize local professional and technical activities. The administration runs along the line of the Region and the Section.



John Vig (left), 2009 IEEE President, presents section banners to both the Benelux & Italian section.

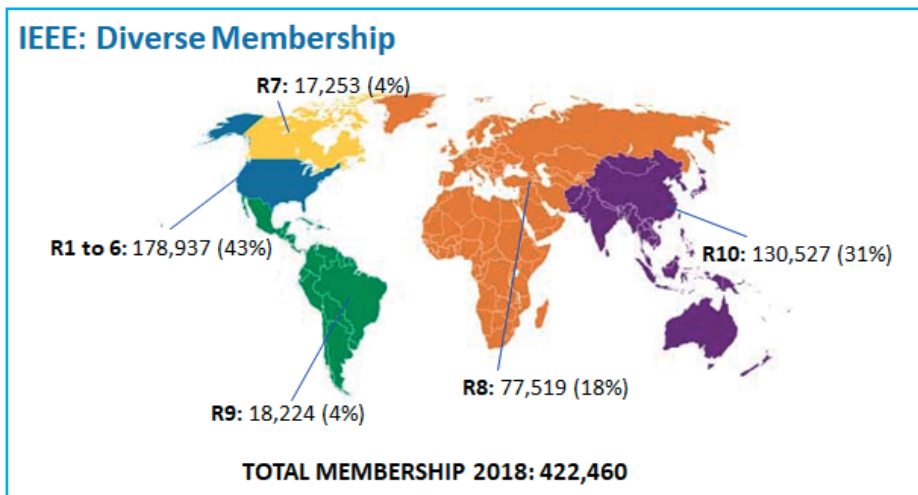

Geographical regions of IEEE, including membership

Activities

With its over 422,000 membership in more than 160 countries the IEEE has a global reach and provides facilities to its members:

- Societies provide benefits to members within specialized fields of interest: society peer-reviewed and top-cited publications
- More than 1900 annual conferences
- More than 1300 active standards
- More than 4M technical documents
- Significant discounts on society publications, conference registration, and other products
- An expansive professional network of worldwide technology experts in many fields of interest
- Continuing education and certification

The global reach is further achieved by IEEE presence in different parts of the world by means of offices at: both U.S. East and West Coast, Europe (Brussels and Vienna), China (Shenzhen and Beijing), India (Bangalore), Japan (Tokyo) and Singapore.

According to its mission the society developed a Code of Ethics. IEEE aims its members to:

- Foster awareness on ethical issues
- Promote ethical behavior among those working within IEEE fields of interest
- Create a world in which engineers and scientists are respected for exemplary ethical behavior

Besides the IEEE is involved in global humanitarian efforts. The IEEE Humanitarian Activities Committee (HAC) is tasked with supporting the board-endorsed vision of IEEE volunteers around the world carrying out and/or supporting impactful humanitarian activities at the local level; i.e. "feet on the ground."

The IEEE Benelux Section

The IEEE Benelux Section was erected in 1959, together with the Italian Section it was the first section in Europe. At the occasion of its fiftieth anniversary, the section banner was presented by the IEEE President John Vig.

The section includes:

- > 3500 members, incl. 740 student members
- 19 chapters, 8 student branches
- 3 Affinity Groups (Women in Engineering, Life Members and Young Professionals)
- Chairman: Mark Bentum (Eindhoven University/Astron)

The section is proud to have three Milestone Awards in its territory today, namely:

- Compact Disc Audio Player, 1979. Dedicated March 2009

- Discovery of Superconductivity, 1911. Dedicated April 2011
- WaveLAN, Precursor of Wi-Fi, 1987. Dedicated October 2019

Still one more application running.

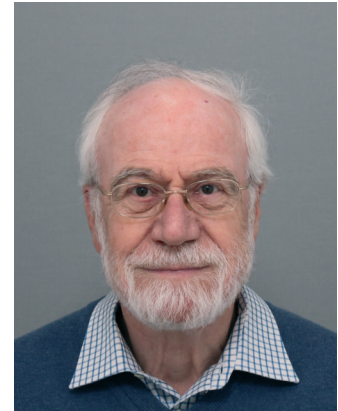

Wim van Etten

Wim van Etten received both the M.Sc. and Ph.D. degrees in electrical engineering from Eindhoven University of Technology, Eindhoven, the Netherlands, in 1969 and 1976, respectively.

In 1970 he was appointed an assistant Professor at Eindhoven University of Technology, Faculty of Electrical Engineering and in 1985 as an Associate Professor. In 1994 he moved to the University of Twente, Enschede, the Netherlands, where he was appointed as a Full Professor of Telecommunications. He retired from this job in 2007.

He is author or co-author of over hundred and fifty papers in international journals, conferences and symposia. He served as a member of organizing committees, program committees and proceedings editor of various conferences and symposia. He is first author of the book "Fundamentals of Optical Fiber Communications", Prentice Hall, 1991. Besides he is the author of the book "Introduction to random Signals and Noise", Wiley, 2005.

From all papers published by IEEE ComSoc in the 50 years' time frame 1953-2002 (more than 28,000 papers), a collection of 57 key papers have been selected. Two of his papers were among that selection. The collection was published in the book "The Best of the Best", Wiley/IEEE, 2007.

He is a senior life member of the IEEE, member of KIVI and the Dutch URSI Committee. For this last institute he serves as the chairman of the supporting foundation.

He was president of the NERG from 1997-2003. He was the vice-chairman of the IEEE Benelux Section 2009-2010 and chairman 2011-2012 and he still is a member of the IEEE Benelux Section Executive Committee. Moreover, he presently is chairman of the IEEE Benelux Life Member Affinity Group.

IEEE MILESTONE

WaveLAN, Precursor of Wi-Fi, 1987

In November 1987, a group of Dutch engineers in Nieuwegein demonstrated a method for significantly increasing the data rate achievable under new regulations that permitted license-exempt short-range wireless data communications in certain frequency bands. Their development of WaveLAN technology led directly to formation of the IEEE 802.11 Working Group for Wireless Local Area Networks and establishment of the now ubiquitous Wi-Fi industry.

October 2019



IEEE MILESTONE

WaveLAN, Voorloper van Wi-Fi, 1987

In november 1987 demonstreerde een groep Nederlandse ingenieurs te Nieuwegein een manier om draadloze datacommunicatie over korte afstand aanzienlijk te verbeteren. Hierbij werd gesteund op nieuwe voorschriften, die licentievrij verkeer toestonden in bepaalde frequentiebanden.

De ontwikkeling van deze WaveLAN-technologie leidde direct tot de oprichting van de IEEE 802.11 standaardisatiegroep voor draadloze lokale netwerken en die van de Wi-Fi-industrie, die nu alom tegenwoordig is.

Oktober 2019



Welcome to Nieuwegein, the birthplace of Wi-Fi

Nieuwegein is a relatively young “new town” (July 1st 1971), with a surprisingly rich history. It was mainly built in the ‘70’s and ‘80’s to meet the rising demand for houses, offices and business parks from the Utrecht region. In between the old villages of Jutphaas and Vreeswijk a new, multifunctional city center was developed. This is the area where NCR was settled and WaveLAN was invented. As a result, Nieuwegein is the “birthplace of Wi-Fi”, which fills me with pride.

Nieuwegein has an interesting cultural-historical value, including the fortifications of a historic line of defense, castles and waterworks. And with the unique archaeological findings from ancient remains of Swifterbant culture (a mother with a child in her arms), Nieuwegein recently added 6,000 years of history.

Nieuwegein is strategically situated on the banks of the Lek river and other waterways and her legal predecessors have always been trading villages. Nowadays this is reinforced by its central place in the Netherlands and the triangle of key traffic arteries nearby. Nieuwegein has become a popular location for the logistics sector and is recently proclaimed as national distribution and e-fulfilment hotspot.

The inhabitants of Nieuwegein have a hands-on mentality. They are inspired by the motto “just do it!”. This entrepreneurial attitude inspires the companies that have settled and still find their way in Nieuwegein. Many of them are working on innovative solutions for practical issues, just like the engineers who invented WaveLAN back in the days.

Over the past 50 years, Nieuwegein has grown to an urban area with 63,000 inhabitants, and this number is still counting. The municipality plans to build 5,000 houses in the next 10 years. Today, the larger development projects are located in the city center, close to the birthplace of Wi-Fi. About 1,650 households can find their new home here. They are part of the goal to be the most sustainable inner city in the Netherlands. Innovation remains of great importance to meet this ambition.

Nieuwegein is honored to host the IEEE milestone plaque in its city hall, the Stadhuis. Not only for its historical importance, but also as a great inspiration for the (technology) future!

Frans Backhuijs
Mayor



*Frans Backhuijs
Mayor of Nieuwegein*



*Swifterbant mother with child
Photo: RAAP, BAAC
Reconstruction: Archeo3D*



City hall of Nieuwegein (Stadhuis)





Nieuwegein



NOKIA

QORVO

