

Price 20 Cents

March, 1917

# THE WIRELESS AGE

WIRELESS COMPANY  
OF SIGNAL CORPS  
IN THE FIELD



The First Wireless Newspaper  
Was Printed at Sea, Nov. 15, 1899.

That paper was the

## OCEAN WIRELESS NEWS

Since then it has been issued daily on all American Steamship Lines. It is a handsome MAGAZINE OF TRAVEL with a three color cover, issued monthly with daily news inserts, printed on board by the wireless operators.

You may have the monthly magazine containing

*Travel Articles*  
*Marine News*

*Illustrated Features*  
*Laughs a-Plenty*

Let twelve numbers come to your hearthside during the coming year, bringing their message of enlightenment on the cities and towns of the Americas, articles of description of peoples and places which make up the real living poetry of the world.

*Ocean Wireless News* does not deal with tourist points in guide-book fashion; that elusive something called atmosphere is what it seeks to delineate—sometimes by description of a single building, perhaps by an incident in local history which established a tradition, and, again, by a human interest anecdote which sets the inhabitants before you in graphic style.

No matter whether the place described is at the northernmost point of the Atlantic Coast or at the very tip of the Americas, the reader is given valuable hints as to what is worth seeing and quiet "tips" as to side journeys to nearby places of more than ordinary interest. You don't travel often. When at home you cannot safely isolate yourself, either intellectually or in practical matters. Broaden your vision of this earth and the people on it.

*Ocean Wireless News* in the home is the pleasantest sort of companion; one dollar will serve as sufficient introduction and invitation to secure this guest permanently the year around.

WIRELESS  
PRESS  
INCORPORATED

42 Broad St.  
New York

I send you one dollar (\$1.50 outside U. S.) for which please enter my subscription for the *Ocean Wireless News* for one year. Begin with the ..... issue.

Name .....

Street Address .....

Town ..... State .....

# THE WIRELESS AGE

An Illustrated Monthly Magazine of  
RADIO COMMUNICATION

Incorporating the Marconigraph

Published by WIRELESS PRESS, INC., 42 Broad St., N. Y. City  
Edward J. Nally, Pres. Charles J. Ross, Vice-Pres. David Sarnoff, Secy. John Bottomley, Treas.

J. ANDREW WHITE, Editor

WHEELER N. SOPER, Asst. Editor

Volume 4 (New Series)

March, 1917

No. 6

### CONTENTS

	PAGE		PAGE
Dangers of the Proposed New Radio Bill .....	374	In Complimentary Vein .....	425
Vessels Recently Equipped with Marconi Apparatus .....	387	Speaking of the N. A. W. A. ....	425
The Share Market .....	387	Wilson Flashes Message to San Diego.	425
Tacoma's Girl Operator .....	387	A Song of Wireless. Verse. By V. C. Jewel .....	426
The Wireless Storm Detector. By W. H. Lawrence .....	388	An Idyl of KPH. By Edward Walden	427
Aeroplane Sets on View .....	395	Another Letter to Mr. Marconi .....	428
General Advice for the Amateur Experimenter. By Elmer E. Bucher.	396	With the Amateurs .....	429
License for Carranza's Operator .....	399	Ready to Test Hammond Torpedo .....	431
Radio Telephony. By Alfred N. Goldsmith, Ph.D. Article III .....	400	High-Power Station Asked for Porto Rico .....	431
Distance Determining Apparatus .....	411	Faults of Amateurs and Suggestions for Improvements. By W. A. Parks .....	432
From and For Those Who Help Themselves .....	412	Medal for Professor Pupin .....	432
A Coast-to-Coast Relay. By gXE, National Chief of Relay Communications, National Amateur Wireless Association .....	423	The War's Wireless Record .....	433
		Some Recommendations for Improved Amateur Legislation. By gXE .....	434
		New Aeroplane Receiving Set .....	435
		New York Signal Corps in the Field .....	436
		Examinations for Radio Operators .....	438
		Queries Answered .....	439

**RENEWALS** When your subscription expires you will find a renewal blank enclosed. You should fill out and return same with remittance at once to avoid missing a number. Positively no copies will be mailed on any subscription after same expires unless renewed, and we cannot agree to begin subscriptions with back numbers.

**CHANGE OF ADDRESS** Notify us promptly of any change in your address, giving both the old and new location. Since our mailing list for each issue closes the 5th of the month, changes received after that date must necessarily take effect with issue for the second month following. Postmaster as well as Publisher should always be notified of changes in order to forward mail sent to old address.

ISSUED MONTHLY BY WIRELESS PRESS, INC.

42 BROAD ST., NEW YORK CITY

Yearly Subscription in U. S. \$2.00; Outside U. S. \$2.48; Single Copies, 20 cents.

Entered as second class matter at the Post Office, New York

STANDARD WIRELESS LITERATURE

**NOTE:** New data and photographs of immense value are still being received from the war fronts, therefore publication has been postponed until MAY. The new material will amply compensate for the delay.

# RADIO TELEPHONY

By ALFRED N. GOLDSMITH, PH.D.

of the Institute of Radio Engineers and College of the City of New York

Dr. Goldsmith has been engaged for several years in exhaustive research in this field, and will compile in this series complete descriptions of all existing operative systems of wireless telephony. He has secured large numbers of new photographs and wiring diagrams, previously unpublished. All this valuable material is available FIRST to the readers of THE WIRELESS AGE, in which the entire series, profusely illustrated, is now being published. All professionals and amateurs who hope to be able to carry on wireless telephony and stay at the front of the "radio procession" need this book.

*A partial summary of topics*

- |  |   |
|--|---|
| <p><b>WORLD ASPECTS</b></p> <p><b>PERSONAL ASPECTS</b></p> <p><b>USES OF RADIO TELEPHONY</b></p> <p>a) Ship-to-ship and ship-to-shore</p> <p>b) Trans-oceanic and trans-continental</p> <p>c) Exceptional regions</p> <p>d) Train-to-train or train-to-station</p> <p>e) Underground, aeroplane, submarine, etc.</p> <p><b>RADIO VERSUS WIRE TELEPHONY</b></p> <p>a) For land telephony</p> <p>b) For oversea telephony</p> <p><b>BROAD PROBLEMS INVOLVED IN RADIO TELEPHONY</b></p> <p>a) Radiation of modulated energy</p> <p>b) Causes of speech distortion</p> <p>c) Distortion of "non-linear" type</p> <p>d) Secrecy in radio telephony</p> <p>e) Strays</p> <p><b>SUSTAINED WAVE GENERATORS</b></p> <p>a) Arcs</p> <p>b) Radio-frequent sparks</p> <p>c) Vacuum tube oscillators</p> <p>d) Alternators of radio frequency</p> | <p><b>MODULATION CONTROL IN RADIO TELEPHONY</b></p> <p>a) Microphone transmitter</p> <p>b) High current microphones</p> <p>c) Vacuum tube types</p> <p>d) Magnetic amplifiers and other controls</p> <p>e) Combination systems</p> <p>f) Comparison of control systems</p> <p><b>ANTENNAS AND GROUNDS</b></p> <p>a) For transmission</p> <p>b) For reception</p> <p><b>RECEIVING SETS</b></p> <p>a) Proportional response</p> <p>b) Selectivity vs. aperiodicity</p> <p>c) Sustained wave beat interference</p> <p>d) Heterodyne radiophonic reception</p> <p>e) Stray interference</p> <p>f) Telephone receivers</p> <p>g) Range in radio telephony</p> <p><b>RADIOPHONE TRAFFIC AND ITS REGULATION</b></p> <p>a) Long distance</p> <p>b) Ship-to-ship and ship-to-shore</p> <p>c) Two-way radio telephony</p> <p><b>FUTURE DEVELOPMENT OF RADIO TELEPHONY</b></p> |
|--|---|

**PRICE**—in advance of publication only—**\$1.25**

Specialists in  
Wireless Literature

Wireless Press, Inc.

42 BROAD ST.  
NEW YORK, N. Y.

STANDARD WIRELESS LITERATURE

## PRACTICAL WIRELESS TELEGRAPHY

By E. E. BUCHER

*Instructing Engineer of the Marconi School  
of Instruction*

**IN PRESS**

An indispensable book for all wireless operators and amateurs who desire to know what's what in the latest and most advanced commercial wireless practice.

The book is very completely illustrated, and covers descriptions, instructions and handling of all the newest types of commercial apparatus, much of which is just going into use, and some of which will not be actually ready for use until 1917.

A complete operators' instruction book in which every detail the commercial operator needs to know is fully and thoroughly covered; generators, dynamos, batteries, high frequency alternators to Poulson arcs—all will be fully described and very carefully explained. This book will be adopted as the official text book of the Marconi School of Instruction, and will undoubtedly be adopted by all the wireless schools in the country.

**PRICE \$1.25, CLOTH BOUND**

WITH ONE YEAR'S SUBSCRIPTION TO THE WIRELESS AGE, \$2.75

## MILITARY SIGNAL CORPS MANUAL

By MAJOR J. ANDREW WHITE

*Chief Signal Officer of the  
Junior American Guard*

**IN PRESS**

Major White has been at work many months to fill a long felt want of a Military Signal Corps instruction book, prepared especially to enable the National Amateur Wireless Association to carry out one of the principal purposes of its organization—the Third Line of National Defense. Every wireless amateur who has a spark of patriotism and desires to serve his country in time of need will feel that he simply must have this book, even though he has no present intention of joining a Signal Corps. It contains such a tremendous amount of valuable information on use of wireless in Signal Corps work that he will want the book anyhow. There is no Signal Corps book in existence today that covers in anything like an adequate way the information given in this book.

**PRICE 50 CENTS**

WITH ONE YEAR'S SUBSCRIPTION TO THE WIRELESS AGE, \$2.25

Specialists in  
Wireless Literature

Wireless Press, Inc.

42 BROAD ST.  
NEW YORK, N. Y.

## PROCEEDINGS OF THE INSTITUTE OF RADIO ENGINEERS

*Giving Every Modern Improvement and  
advance. Always up-to-date.*

The most recent inventions in radio telegraphy and telephony are accurately and fully described by the engineers who discovered them.

There is no better way of following the trend of radio work than thru its pages.

8vo.—600 pp.—Buckram Binding—PRICE \$6.00 Net.  
WITH ONE YEAR'S SUBSCRIPTION TO THE WIRELESS AGE, \$7.50.

## PRINCIPLES OF WIRELESS TELEGRAPHY

By **GEORGE W. PIERCE, A.M., Ph.D.**

*Assistant Professor of Physics in Harvard University*

**Theory - Application - Construction**

A book for students of electricity and those engaged in operating and constructing wireless telegraph apparatus.

It covers the field under the following heads:

I. The fundamental reasoning and experiments leading to the conception of electric waves.

II. The properties of electric waves and oscillations.

III. The applications of electric waves to wireless telegraphy.

IV. The principles and methods of wireless telegraphy for the use of students, and amateur and professional operators.

Professor Pierce has played an important part, both in the scientific and practical development of wireless telegraphy. His work is a practical, non-mathematical book for use as a text or reference work. It is based on his course in this subject at Harvard University. It begins with simple theory, covers methods and principles, and goes thoroughly into construction, operation, data, etc. It is a complete and logical analysis of the field of electric-wave telegraphy from the viewpoint of the most modern practice.

### CONTENTS.

Introduction—Theories as to the Nature of Electricity—Relation Between Electricity and Magnetism—Resemblance of Self-Induction to Mechanical Inertia—Electrostatic Capacity—Discharge of a Condenser Through an Inductance and Resistance—Maxwell's Theory. Electric Waves. Electromagnetic Theory of Light—Experiments of Hertz—Experiments on the Identity of Electric Waves and Light—Propagation of Electric Waves on wires—Wireless Telegraphy Before Hertz—Wireless Telegraphy by Hertzian Waves. Marconi, 1896-1898—Electric Wave Telegraphy by Resonant Circuits—Nature of the Oscillation. The Grounding of Circuits—Propagation Over the Earth—Detectors—Crystal Rectifiers Electrolytic Detector and Vacuum Detectors—

Electrical Resonance. Wave Meters. Resonance in Simple Condenser Circuits—Electrical Oscillations of Connected Systems of Condenser Circuits—Tuning the Sending Station—Some Recent Methods of Exciting Electric Waves. The Singing Arc, the Singing Spark, and the Quenched Spark—Resonance of receiving Circuits. The Possibility of Preventing Interference—Directed Wireless Telegraphy—Wireless Telephony—Some Details of Construction of Wireless Telegraphic Apparatus—Conclusion.

APPENDIX I. Elementary Facts About Electricity, and Definitions of Units.

APPENDIX II. Concerning the Calculation of Resistance, Self-Inductance and Capacity.

Cloth. 350 pp. 6 x 9. 235 Illustrations. PRICE \$3.00.

With One Year's Subscription to The Wireless Age, \$4.50

Specialists in  
Wireless Literature

Wireless Press, Inc.

42 BROAD ST.  
NEW YORK, N. Y.

## WIRELESS TELEGRAPHY and TELEPHONY

By **A. E. KENNELLY, A.M., Sc.D.**

*Professor of Electrical Engineering  
in Harvard University*

Gives in simple language an explanation of electro-magnetic waves and their propagation through space; also the fundamental and essential principles of both wireless telegraphy and wireless telephony. A complete, authoritative and popular presentation of these latest of modern scientific wonders, down to their latest developments.

### CONTENTS.

Introductory—Waves and Wave-Motion—Magnetism and Electricity—Electromagnetic Waves Guided Over Conductors—Electromagnetic Waves Guided by Single Wires—Radiated Electromagnetic Waves Guided by the Ground—Unguided or Spherically Radiated Electromagnetic Waves—Plane Electromagnetic Waves—The Simple An-

tenna or Vertical Rod Oscillator—Electromagnetic Wave-Detectors or Wireless Telegraph Receivers—Wireless Telegraph Working—Tuned or Selective Signaling—Measurements of Electromagnetic Waves—Industrial Wireless Telegraphy—Considerations Preliminary to Wireless Telephony—The Principles of Wire Telephony—Principles of Wireless Telephony.

Revised and Enlarged Edition.

Cloth. 279 pp. Illustrated. PRICE \$1.25.

With One Year's Subscription to THE WIRELESS AGE, \$2.50.

## WIRELESS TELEGRAPHY

By **DR. J. ZENNECK**

*Professor of Physics at the Technical High  
School of Munich*

Translated from the German  
By A. E. SEELIG, E. E.

Dr. Zenneck's "Lehrbuch der drahtlosen Telegraphie" has been widely known to students of the subject for many years. It has been the standard of the military and naval service, as well as the technical schools, of Germany since first publication.

In the present authorized translation, the latest German edition has been used. The translator has brought to the work a broad experience obtained as General Manager of the Atlantic Communication Company.

The work is the most scientific and thorough that has appeared on this subject. It covers all phases from physical principles to finished commercial apparatus. The method of treatment is technical and the scope of the book comprehensive.

An especially full and valuable bibliography is included.

### CONTENTS.

The Natural Oscillations of Condenser Circuits—Open Oscillators—The High Frequency Alternating-Current Circuit—Coupled Circuits—Resonance Curves—The Antenna—Transmitters of Damped Oscillations—High Frequency Machines for Undamped Oscillations—Undamped Oscillations by

the Arc Method—Propagation of the Waves Over the Earth's Surface—Detectors—Receivers—Directive Telegraphy—Wireless Telephony. Development of Wireless Telegraphy—Tables—22 Pages of Useful Tables. Bibliography and Notes on Theory. INDEX.

Cloth. 443 pp. Size 6 x 9. 461 Illustrations. PRICE, \$4.00.

With One Year's Subscription to THE WIRELESS AGE, \$5.50.

Specialists in  
Wireless Literature

Wireless Press, Inc.

42 BROAD ST.  
NEW YORK, N. Y.

## RADIODYNAMICS

The Wireless Control of Torpedoes and Other Mechanisms

By **BENJAMIN FRANKLIN MIESSNER**

Associate Member Institute of Radio Engineers  
Expert Radio Aide, United States Navy

A general descriptive treatment of radiodynamics, especially in connection with mechanisms operated at a distance. This work treats of control systems which utilize the natural media, *i. e.*, ether, air, water, or earth, as the connecting link between the control apparatus and the mechanisms to be controlled.

### CONTENTS.

The evolution of telemechanics, the art of controlling mechanisms from a distance through electrical conductors—Evolution of Radio Telegraphy, the Art of Signaling to a Distance Through the Natural Media—Practical Wireless Telegraphy—Electrostatic and Combined Induction-Conduction Telegraph Systems—Electromagnetic Wave Systems of Signaling—Possible Control Methods for radio dynamics. Sound Waves—Infra-Red or Heat Waves—Visible and Ultra-Violet Waves—Earth Conduction—Electrostatic and Elec-

tromagnetic Induction. Hertzian Waves—The Advent of Wirelessly Controlled Torpedoes—Selectors. Classification of Control Systems—European Control Systems and Apparatus—Torpedo Control Problems. Improvements in Receiving Apparatus—Methods of Obtaining Selectivity—Detectors for Radio Dynamics and Torpedo Control—Means of Amplifying Received Currents—Sensitive Relays for radio dynamics—Types of Antennae Suitable for Radio Dynamic Torpedoes—Recent Developments.

Cloth. 211 pp. Size 5½ x 8½. 112 Illustrations. \$2.00.

With One Year's Subscription to THE WIRELESS AGE, \$3.50.

## PRACTICAL USES OF THE WAVE METER IN WIRELESS TELEGRAPHY

By **J. O. MAUBORGNE**

First Lieutenant 24th U. S. Infantry; formerly Instructor  
Army Signal School, Fort Leavenworth, Kansas

A book of practical value to all interested in wireless telegraphy. A full knowledge of the principles and practical uses of the wave meter is not only of value to every operator, but essential under the present statutes. Prepared first for use at the Army Signal School, Fort Leavenworth, Kansas. It was adopted by direction of the Secretary of War for use at that school.

The present work is a thorough revision and enlargement to meet the needs of commercial operators and technical schools.

### CONTENTS.

General Remarks—Types of Wave Meters in Use in the U. S. Signal Corps—Uses of Wave Meters; Measurements of Wave Lengths—Tuning the Sending Station—Measurement of Damping and Logarithmic Decrement; Measurement of Damping of a Closed Oscillatory Circuit—Measurement of Wave Length of the Receiving Station—Measurement of Capacity and Inductance.

Cloth. 74 pp. Size 6 x 9. Illustrated. PRICE \$1.00.

With One Year's Subscription to THE WIRELESS AGE, \$2.50.

Specialists in  
Wireless Literature

Wireless Press, Inc.

42 BROAD ST.  
NEW YORK, N. Y.

## THE BOOK OF WIRELESS

By **A. FREDERICK COLLINS**

Inventor of the Collins Wireless Telephone System  
and a National Authority on Wireless

This recent book on wireless telegraphy was written to meet the needs of the thousands of young men who are interested in wireless and are eager to set up and operate their own stations, but who do not know how to go about it.

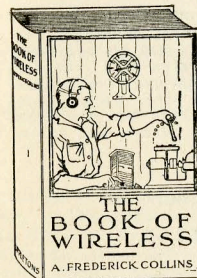

### YOU MAY NOW HAVE YOUR OWN WIRELESS STATION

If you are a wireless enthusiast you need not postpone your pleasure another day. **THE BOOK OF WIRELESS** tells you all you need to know to set up a complete station for both receiving and sending messages. It isn't necessary for you to know anything about electricity or anything else connected with the subject, for the author begins at the beginning and explains everything down to the smallest details. Everything you need to know you will find here in black and white. Another important point—he tells you what you want to know when you want to know it. Everything is arranged in logical order; when a point needs explaining it is explained then and there. You can work as you read; and as you proceed with the construction of your plant, you will find each operation explained as you are ready for it.

Every operation is made still clearer by means of **MORE THAN 200 ILLUSTRATIONS BY THE AUTHOR.**

These have all been drawn to scale and are absolutely accurate. With the **BOOK OF WIRELESS** to help you, the work of putting up a wireless station becomes mere child's play.

After your wireless plant is ready, the author shows how to operate it, using the American and International Morse Codes.

Cloth bound, 222 pages, Price \$1.00

With One Year's Subscription to THE WIRELESS AGE, \$2.25

## A HANDBOOK OF WIRELESS TELEGRAPHY

By **JAMES ERSKINE-MURRAY, D.Sc., F.R.S.E.**

A handbook for the use of Electrical Engineers, students and operators. "A serious and meritorious contribution to the literature on this subject. The author brings to bear not only great practical knowledge, gained by experience in the operation of wireless stations, but also a very sound knowledge of the principles and phenomena of physical science. His work is thoroughly scientific in its treatment, shows much originality throughout, and merits the close attention of all students of the subject."—Engineering (London).

Cloth. 8vo. Illustrated. Price \$3.75 net.

With One Year's Subscription to THE WIRELESS AGE, \$5.00

Specialists in  
Wireless Literature

Wireless Press, Inc.

42 BROAD ST.  
NEW YORK, N. Y.

**EXPERIMENTAL WIRELESS STATIONS**By **PHILIP E. EDELMAN**

A book for amateurs, detailing the theory, design, construction and operation of Standard Wireless Stations, including wireless telephony and quenched spark systems. It was prepared for experimenters who regard "wireless" as more than a plaything. It is intended to serve as a stepping stone to serious preparation for high positions in the practical field of the "Wireless" profession.

It enables you to master the important principles and working methods of modern wireless systems in a very short time, to build the apparatus, study the principles of transmission, perform all calculations using simple arithmetic only, to design and use efficient stations and instruments and to have no end of real instruction and pleasure in getting the greatest possible benefits from the art.

How to tune, how to find your range and wave length, which detectors are most sensitive, how to make all sizes of spark coils and transformers, how to make standard apparatus now manufactured, wireless telephones, and quenched arcs,—all of these and hundreds of other useful items are fully presented. Then there are simplified formulas, diagrams, hook-ups, curves, and tables, in fact everything you want.

Cloth. 272 pp. 5½ x 8. Many Diagrams. PRICE \$1.50.

With One Year's Subscription to THE WIRELESS AGE, \$2.50.

**EXPERIMENTS**By **PHILIP E. EDELMAN**

Author of "Experimental Wireless Stations," Etc.

This book gives practical information for building simple, efficient apparatus at small cost, for conducting tests and experiments, for establishing a laboratory, and for applying the best experimental methods.

It is the book for those who wish to make their experimental work count for something. The facts stated are accurate, the tables and data invaluable, yet the text reads interestingly. Practically every question which may confront a reader in either an amateur or commercial problem is anticipated in this book.

## CONTENTS

Models, Copies and Makeshifts—Simple Chemical Experiments—Miscellaneous Applications of Chemistry—Catalytic Experiments—Deposition of Metals and Electroplating—Electro-chemistry—Electric Motors—Electric Heating Devices and Experiments—The Electric Arc—Welding and Talking—Simple Electrical Devices—Electrical Transformers, Induction Coils and Applications, including an Ozonator—Wireless Telegraphy, Telephony and Control Apparatus—Telegraphy and Picture Transmission—High Frequency Apparatus and Experiments—Phosphorescence and Ultra-violet Light—Experiments with Graphite—Radiography and X-

rays—Electrical A. C. and D. C. Experiments—Static Electricity, Apparatus and Experiments—Mechanical Devices and Physical Experiments—Experiments in Horticulture—Model and Applied Aeronautics—Microscopes and Microscopic Photography—Suggestions for a Laboratory—Science and Invention—Essential Processes in Experiments—Fundamental and Experimental Principles—Preliminary Experimental Work—How an Original Research is Conducted—Radio Research—Simple and Industrial Testing—Commercial Experiments—The Tomorrows of Experimental Research—Index.

"It is quite unique and invaluable to anyone engaged in research work. 'Experiments' covers a field that is yet comparatively barren of reference works."—Modern Mechanics, N. Y. C.

Cloth. 256 pp. 5½ x 8. 200 Illustrations. PRICE \$1.50.

With One Year's Subscription to THE WIRELESS AGE, \$2.50.

Specialists in  
Wireless Literature

Wireless Press, Inc.

42 BROAD ST.  
NEW YORK, N. Y.**PRACTICAL ELECTRICITY**

An Elementary Textbook

Principles — Arithmetical Problems — Experiments

C. WALTON SWOOPE

Associate Member American Institute of Electrical Engineers.

Late Instructor of Applied Electricity at the Spring  
Garden Institute, Philadelphia

This book combines the principles of electricity upon which the practical applications of to-day depend, with the experimental demonstration of these principles and the elements of the arithmetics of electricity used in making practical electrical measurements and calculations.

## CONTENTS.

Magnetism—Magnetisation—Magnetic Fields—Theory of Magnetism—Magnetic Induction—Magnetic Circuits—Earth's Magnetism—Voltaic Electricity—Batteries—Electrolysis—Measurement of Current Strength—Resistance—Ohm's Law and Battery Connection—Circuits and Their Resistance—Electromagnetism—Galvanometers—Elec-

tromagnets—Ammeters—Electrical Work and Power—Measurement of Pressure—Measurement of Resistance—Electrical Development of Heat—Electrodynamics—Electromagnetic Induction—The Induction Coil—Dynamo Electric Machines—Armatures—Direct Current Dynamos—Direct Current Motors—Electric Lighting—Alternating Currents. Tables. Formulas.

Fifteenth Edition—With a Revised Chapter on Electric Lighting.

5½ x 7¾. 404 Illustrations. 517 pp. Weight 2 lbs. Net \$2.00.

With One Year's Subscription to THE WIRELESS AGE, \$3.50.

**ELEMENTARY PRINCIPLES OF WIRELESS TELEGRAPHY**By **R. D. BANGAY**

This book explains in the simplest manner the theory and practice of wireless telegraphy. It makes the subject intelligible to those who possess limited technical knowledge and is adapted particularly to the needs of students, amateurs and Boy Scouts.

## CONTENTS.

Morse Code—Symbols Used in Diagrams—Electricity and Magnetism—Magnetism—The Principles of Wave Motion—Pressure Waves—Production of Electric Waves—Production of Oscillating

Currents in an Aerial—Coupled Oscillatory Circuits—The Wavemeter—Wireless Telegraph Receivers—The Tuning Buzzer—The Magnetic Detector "Atmospherics"—Aerials—Index.

Cloth. 160 pp. Many Illustrations. PRICE 50 cents.

With One Year's Subscription to THE WIRELESS AGE, \$2.25.

Specialists in  
Wireless Literature

Wireless Press, Inc.

42 BROAD ST.  
NEW YORK, N. Y.

*Elementary Manual of*  
**RADIOTELEGRAPHY and RADIOTELEPHONY**  
 For Students and Operators

By **J. A. FLEMING, M.A., D.Sc., F.R.S.**

*Professor of Electrical Engineering in the University of London, Member  
 of the Royal Institution of Great Britain*

This book contains complete information to enable students and operators and amateurs familiar with the elementary facts of electricity and magnetism to master RADIOTELEGRAPHY and RADIOTELEPHONY. It explains the scientific principles underlying the Radio art in a manner suitable for students, operators and amateurs and general readers. "WIRELESS" has gained such importance in Naval and Military signalling and in marine and land communication that adequate means of teaching the subject to electro-technical students and practical operators and amateurs, are required. Dr. Fleming's book meets that demand.

CONTENTS

Electric Oscillations and Electric Resonance— and Receiving Circuits—Oscillation Detectors—  
 Damped Electric Oscillations—Undamped Electric Radiotelegraphic Stations—Radiotelegraphic  
 Oscillations—Electromagnetic Waves—Radiating Measurements—Radiotelephony.

THIRD EDITION, REVISED AND ENLARGED

Cloth. 360 pp. 6 x 9. Many Diagrams and Illustrations. Price, \$2.00.  
 With One Year's Subscription to THE WIRELESS AGE, \$3.50.

**HOW TO PASS U. S. GOVERNMENT  
 WIRELESS LICENSE EXAMINATIONS**

By **E. E. BUCHER**

*Instructing Engineer of The Marconi School  
 of Instruction*

THIRD EDITION LARGELY REVISED AND EXTENDED.

142 QUESTIONS AND ANSWERS

CONTENTS

Explanation of Electrical Symbols—Definitions of Electrical Terms—Part I. Transmitting Apparatus—Part II. Motor Generators—Part III. Storage Batteries and the Auxiliary Set—Part IV. Antenna or Aerials—Part V. Receiving Apparatus—Part VI. Radio Laws and Regulations—Part VII. General Information Concerning Operator's License Examinations—Practical Equations for Radio Telegraphy—Equations for Ordinary Power Work.

READ What the Man Who Employs the MARCONI OPERATORS Says of This Book:

I have read your recent publication entitled "How to Pass the Government Wireless Examination." I consider it invaluable to all aspirants who wish to become commercial operators. Operators will also find this little volume extremely useful in assisting them to obtain renewal of their licenses.

The author, who has had many years of experience in the commercial field of wireless Telegraphy and who speaks from experience, is perhaps better qualified than any one I know of to compile a book of this kind.

Yours very truly,

**E. T. EDWARDS, Superintendent.**

EDUCATIONAL INSTITUTIONS all over the Country are Using This Book

50 Cents. Weight One Pound. Postage Extra.

Specialists in  
 Wireless Literature

**Wireless Press, Inc.**

42 BROAD ST.  
 NEW YORK, N. Y.

**WIRELESS TELEGRAPH CONSTRUCTION  
 FOR AMATEURS**

By **ALFRED P. MORGAN**

**Build Your Own Wireless Outfit**

Shows you how to construct various outfits capable of receiving from 100 to 1500 miles and transmitting from 3 to 100 miles, giving in minute detail complete directions for the construction of each part. Also clearly explains the purpose and action of each instrument with directions for operating and testing, etc.

Its thoroughness is a feature not often shown in such books: this together with its splendid treatise of wireless along constructive lines makes it the ideal book for an amateur. It embodies all improvements and changes which have taken

place. Photographs and working drawings of a great many new instruments accompanied by full descriptive matter explaining the construction of new types of apparatus, and a full copy of the Wireless Law is included.

CONTENTS

Introductory, The Apparatus, Aerial and Earth Connections, Induction Coils, Interrupters, Transformer, Oscillation Condensers and Leyden Jars, Spark Gaps or Oscillators, Transmitting Helixes, Keys, Aerial Switches and Anchor Gaps, Hot Wire

Ammeter, Oscillation Detectors, Tuning Coils and Transformers, Receiving Condensers, Telephone Receivers and Headbands, Operation, The Amateur and Wireless Law, What it is, How to Comply, How to Secure a License, Appendix, Index.

Every wireless amateur or experimenter should have a copy of this splendid book. Send for a copy today.

Revised and Enlarged Edition.

Cloth. 225 pp. 167 Illustrations. PRICE \$1.50.

With One Year's Subscription to THE WIRELESS AGE, \$3.00.

**HANDBOOK OF TECHNICAL INSTRUCTION  
 FOR WIRELESS TELEGRAPHISTS.**

By **J. C. HAWKHEAD and H. M. DOWSETT**

Arranged to meet the requirements of candidates for appointment as sea or land operators and other students of wireless telegraphy. It enables the sea operator particularly to fully master all details of the construction, efficient operation and maintenance of his station.

Completely revised and up-to-date, with full description of both new and old types of apparatus.

CONTENTS.

Preliminary Considerations—Primary Cells—Accumulators—Current Electricity: Its Laws and Units—Magnetism—Electro Magnets—Dynamo, Motor, Rotary Converter—Inductance—Direct and

Alternating Current Measurements—Condensers—Electromagnetic Waves—The Receiving Circuit—1½ K.W. Sets—Emergency Transmitting Apparatus—The 1½ K.W. Aerial—½ K.W. Sets—5 K.W. Sets—Portable Sets—Faults—INDEX.

Cloth. 309 pp. Many Illustrations. PRICE \$2.00.

With One Year's Subscription to THE WIRELESS AGE, \$3.50.

Specialists in  
 Wireless Literature

**Wireless Press, Inc.**

42 BROAD ST.  
 NEW YORK, N. Y.

## WIRELESS TELEPHONES

By *JAMES ERSKINE-MURRAY, D.Sc., F.R.S.E.*

A well balanced sketch of a complex subject, showing the leading principles in their proper values and excluding a mass of details of lesser importance. Chapter subjects include: How We Hear; Historical; The Conversion of Sound into Electrical Waves; Wireless Transmission; The Production of Alternating Currents of High Frequency; How Electric Waves are Radiated and Received; The Receiving Instruments; Detectors; Achievements; Glossary; Complete Index.

Cloth. 8vo. Illustrated. PRICE 60 cents, net.

With One Year's Subscription to THE WIRELESS AGE, \$2.25.

## MANUAL OF WIRELESS TELEGRAPHY FOR USE OF NAVAL ELECTRICIANS

By *COMMANDER S. S. ROBISON, U. S. N.*

The textbook of the practice of Wireless as used in the United States Navy; containing description of installation, care and operation and service regulations. Invaluable to Navy radio operators and electricians.

**GENERAL REVIEW OF FACTS RELATING TO HIGH FREQUENCY CURRENTS.** Electricity; Magnetism; Electro Magnetism; Electro Magnetic Induction; Methods of Producing Currents by Electro-Magnetic induction; Method of Producing Currents Used in Wireless Telegraphy; Electric and Magnetic Fields; Electric Capacity; Electric Induction; Electric Condensers; Discharge of Condensers; Ether Waves; Reflection; Refraction; Diffraction.

**PRODUCTION, RADIATION AND DETECTION OF ETHER WAVES.**

**ELECTRIC UNITS AND THEIR RELATIONS TO EACH OTHER.** Foot Pound Minute; Centimeter-gram-second; Power; Work; Dyne; Erg; Volt; Ampere; Ohm; Watt; Coulomb; Farad; Henry.

**CAPACITY AND SELF-INDUCTION.** Fundamental Equation of Wireless Telegraphy; Work Required to Create a Current; Work Required to Charge a Condenser; Combination of Capacity and Self-Induction; Condensers and Inductances in Series and Parallel; Capacity and Self-Induction of Straight Wires; Time Constants of Condensers and Inductive Circuits; Difference Between D.C. and A.C. Due to Self-Induction and Capacity;

**Skin Effect of High Frequency A.C.; Measurement of Capacity and Self-Induction; Work Done in Producing Electric Waves and Making Dots and Dashes of the Telegraph Code.**

**POWER EXPENDITURE AND EFFICIENCY OF SENDING AND RECEIVING APPARATUS.**

**SENDING CIRCUITS AND APPARATUS.** Generators, Transformers, Regulation of Sending Sets; Sending Keys; Closed Circuit Inductances; Condensers and Condenser Material; Spark Gaps, Energy Transfer Between Closed and Open Circuits; Limitations on Wave Lengths; Aerials (Antenna); Lightning Switch; Open Circuit Inductances; Variometers; Hot Wire Ammeter, Grounds and Ground Connections.

**RECEIVING CIRCUITS AND APPARATUS.** Open Circuit; Closed Circuit; Inductances; Condensers; Detectors; Telephones; Batteries, Buzzers; Ampliphones; Recorders; Portable Sets.

**INSTALLATION.** Installation; Adjustments, Calibration; Tuning; Wave Meters and Their Use; Measurements.

Third Revised and Enlarged Edition.

Cloth. 243 pp. Many Illustrations and Diagrams. PRICE \$1.50, Net

With One Year's Subscription to THE WIRELESS AGE, \$3.00.

Specialists in  
Wireless Literature

Wireless Press, Inc.

42 BROAD ST.  
NEW YORK, N. Y.

## CURRENT EDITION OF THE YEAR BOOK OF WIRELESS TELEGRAPHY AND TELEPHONY

1000 PAGES

SIZE 6 x 8 1-2

THE ONLY COMPLETE REFERENCE WORK ON WIRELESS WITH  
NEW AND IMPORTANT DATA

Contains a yearly record of the progress of wireless telegraphy; the regulations of the International Convention; the radio laws of all countries; complete lists of ship and shore stations throughout the world, their call letters, wave-lengths, range and hours of service; articles by the greatest authorities on vital questions, the Articles of the International Convention on Safety of Life at Sea; application of wireless to the mercantile marine; the technical situation of radiotelephony—in fact, everything YOU haven't been able to find out elsewhere. Also a full glossary of the most useful wireless data ever compiled.

### SPECIAL ARTICLES IN LATEST EDITION

Intelligence in Naval Warfare, by Archibald Hurd.  
Photo-electric Phenomena, by Dr. J. A. Fleming.  
The Allies' Strategy in 1915, by Col. F. N. Maude,  
C. B.

Capacitance, Inductance and Wave-Lengths of  
Antennae, by W. H. Eccles, D. Sc.  
Wireless Waves in the World War. A general  
survey of war happenings affecting Radio-tele-  
graphy, by H. J. B. Ward, B. A.  
The Progress in Radio Telephony in U. S. A.  
During 1915.

Report of British Association for the Advance-  
ment of Science.

Measurement of Signal Intensity, by John L.  
Hogan, Jr.

The Problems of Interference, by Percy W. Harris.  
Long Distance Services.

Brief Outline of Radiographic Progress.

International Time and Weather Signals.

Formulae and Equations.

Useful Data.

PRICE, \$1.50, Including the Wireless Map of the World

POSTAGE EXTRA

WEIGHT 4 LBS.

FOREIGN POSTAGE 48c

SPECIAL OFFER WITH THE WIRELESS AGE FOR ONE YEAR \$2.50

## WIRELESS TRANSMISSION OF PHOTOGRAPHS

By *MARCUS J. MARTIN*

117 PAGES.

62 DIAGRAMS AND ILLUSTRATIONS.

### CONTENTS:

Introductory—Transmitting Apparatus—Receiving Apparatus—Synchronising and Driving—The Telephotograph—Selenium Cells—Preparing the Metal Prints—Index.

PRICE, \$1.00

WEIGHT ONE LB.

POSTAGE EXTRA

## BOUND VOLUMES AND BINDERS FOR THE WIRELESS AGE

We can supply back numbers of THE WIRELESS AGE at 15c each, beginning Oct., 1913, with the exception of Dec., 1914, and Jan., June, July and Aug., 1915.

**BOUND VOLUMES.** We have a very few bound volumes of THE WIRELESS AGE. While they last Vol. I at \$3.00 each. Vol. III, Now Ready, Oct. '15 to Sept. '16, \$2.50 each. Binders only for Vol. III, 75c each.

Specialists in  
Wireless Literature

Wireless Press, Inc.

NEW YORK, N. Y.  
42 BROAD ST.



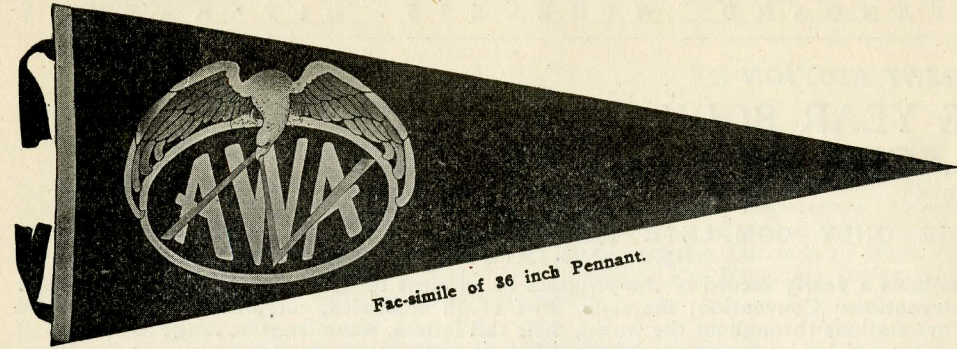

# National Amateur Wireless Association

Founded to promote the best interests of radio communication among wireless amateurs in America.

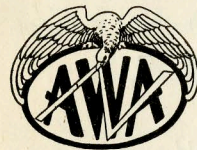

## OFFICERS OF THE ASSOCIATION.

PRESIDENT, Guglielmo Marconi.

### NATIONAL ADVISORY BOARD OF VICE PRESIDENTS

Professor A. E. Kennelly,  
Harvard University.  
President, Institute of Radio Engineers.

Professor Samuel Sheldon,  
Polytechnic Institute of Brooklyn.

Professor Alfred N. Goldsmith  
College of the City of New York.

Professor Charles R. Cross,  
Massachusetts Institute of Technology.

Hiram Percy Maxim,  
President, American Radio Relay League.

Major William H. Elliott,  
Adjutant General, Junior American Guard.

Commander D. W. Todd, U. S. Navy, Director of Navy Communication Service.  
Capt. W. H. G. Bullard, U. S. N., former Superintendent, U. S. Naval Radio Service.

Lieut.-Col. Samuel Reber, Signal Officer, U. S. Army.

E. E. Bucher, Instructing Engineer, Marconi Wireless Telegraph Company.

### ADMINISTRATIVE OFFICERS:

ACTING PRESIDENT,  
J. Andrew White,  
Editor, THE WIRELESS AGE.

SECRETARY,  
Alonzo Fogal, Jr.,  
42 Broad Street, New York.

### MEMBERS' EQUIPMENT.

**1st. CERTIFICATE OF MEMBERSHIP.**  
The handsomely steel-engraved Certificate, with shadow background half-tone, is sealed and signed by Officers, with the endorsement of Senatore Marconi, as President. Every member will want to frame and place it alongside of his Government License certificate, two documents establishing status as wireless amateurs.

**2nd. AERIAL PENNANT.**  
The 26 inch aerial pennant, painted in four colors on scarlet felt, will stand long service at your aerial mast head. Every member will be proud of the National Insignia flying from his aerial. Extra pennants to members only 80c each.

**3rd. MEMBERSHIP PIN.**  
The National Amateur Wireless Association Pin in

gold and enamel is the National emblem of the Association. The design shown on the preceding page can but faintly describe its handsome appearance in three colors and gold. The pin has a special patented hub and shank which permits it being securely fastened on the coat lapel or on the vest without turning upside down.

**4th. LIST OF RADIO STATIONS OF THE WORLD.**  
Revised Edition just published. See advertisement.

**5th. HOW TO PASS U. S. GOVERNMENT WIRELESS LICENSE EXAMINATIONS.**  
Regular edition of this popular book. See advertisement.

### 6th. HOW TO CONDUCT A RADIO CLUB.

This splendid book, incorporates portions of articles running under the same title in THE WIRELESS AGE, re-written to cover every new development, and with a large proportion of new matter. It is the foundation stone of the National Amateur Wireless Association activities.

### 7th. MONTHLY BULLETIN SERVICE.

The monthly bulletin service for members of the National Amateur Wireless Association is one of the most important features of the Association. This bulletin is to be used in connection with "List of Radio Stations of the World" described above. It carries all additions (both amateur and commercial) to "List of Radio Stations of the U. S.", issued by the Bureau of Navigation, U. S. Department of Commerce, and secured for members at 18c a copy. The Government list is issued only once a year. The Association Bulletin will keep both lists up to date for you month by month, and in addition, will carry other special and invaluable Association features not obtainable elsewhere.

### CHARTERS FOR CLUBS.

Out of the amount paid by each member for annual dues, organizations that become part of the National Amateur Wireless Association will be allowed a rebate of 50 cents out of each \$3.00 for their own treasury—a fund to take care of local expenses. Please note that this is a rebate, not a deduction. In order to qualify for recognition as

### 8th. ONE YEAR'S SUBSCRIPTION TO THE WIRELESS AGE.

THE WIRELESS AGE is the Official Organ of the National Amateur Wireless Association and will contain full reports of wireless amateur activities, both national and local. It is planned to give published recognition to individual amateur achievement.

### INITIATION FEE.

An initiation fee of \$1.00 is required of all new members to pay for the initial membership equipment, consisting of Nos. 1, 2, 3, 4, and 5.

### ANNUAL DUES.

The annual dues are \$2.00. For this, all members are to receive:

- 1st. The Monthly Service Bulletin.
- 2nd. THE WIRELESS AGE for one year.
- 3rd. 10% discount on any book on wireless published, and other features to be announced later.

a unit in the National Amateur Wireless Association, a club must have at least five members and at least one-quarter of its total membership become members of the National Amateur Wireless Association. Clubs securing a charter will elect their own delegates to the National Council and thus secure a voice in the management of the Association and in the planning of its future development and activities.

Checks and money orders should be made payable to: Natl. Amateur Wireless Assn.

### APPLICATION FOR MEMBERSHIP.

ALONZO FOGAL, JR., Secretary,

NATIONAL AMATEUR WIRELESS ASSOCIATION,  
42 Broad Street, New York City.

Date.....

As I desire to receive full recognition as an amateur wireless worker of the United States, I ask the privilege of enrollment as a Member in the National Amateur Wireless Association and request that you send me the complete Members' Equipment for which I enclose herewith remittance of \$1.00 Initiation Fee, covering Initial Equipment, and \$2.00 for First Annual Dues—or \$3.00 in all. Out of the \$2.00 Annual Dues 50c. is to go to pay for one year's subscription to the Monthly Service Bulletin and \$1.00 is to go to pay for one year's subscription to THE WIRELESS AGE.

I trust that you will act upon my application promptly and forward the equipment to me at the earliest possible date.

Signature ..... Age.....

Street Address .....

Town and State.....

### \* Option.

In the event that an applicant is unable to send the entire amount of the membership dues with this application, the figure \$3.00 may be crossed out and \$1.00 written in its place. This will be considered an agreement on the part of the applicant accepted for Membership that the balance of dues (\$2.00) will be paid at the rate of 50c. per month for the next four months, at which time Certificate of Membership will be issued. The other equipment will be sent at once.

### ANSWERS TO THESE QUESTIONS

1—Have you a Government License (give number.....) or do you purpose applying for one?.....

2—If you are under 21 years of age, give names of two adults, for references as to character.....

3—If you are a member of any Local, State or Interstate wireless club or association, give its name, and name of Secretary with address.  
.....

## N. A. W. A. Protection for Purchasers of Wireless Equipment

From June N. A. W. A. Monthly Service  
Bulletin.

"During the last few months we have received a number of complaints from members who have purchased wireless apparatus from different supply houses. In most cases the complaints were to the effect that they had ordered such and such a piece of apparatus and made remittance on such and such a date, and that they received an acknowledgment of the order, but had never received the apparatus; nor could they get any satisfaction from the companies, although repeated complaints had been made. We have taken up these cases of members, have written the manufacturers and have secured prompt action and satisfaction in several cases.

"In a recent case, one of our members in Massachusetts wrote, 'I received shipment of my transformer one week after you wrote the company on this subject and wish to compliment you for accomplishing with one letter what I could not accomplish with a half dozen.'

"If members will exercise a little care in placing their orders and place only with reputable concerns who manufacture dependable goods, they will have little trouble. It is the small, 'fly-by-night' concerns, here to-day and gone to-morrow, that put out cheap apparatus at prices too low to make it possible for them to deliver anything worth while who have cheated hundreds of amateurs out of their money. Study the catalogs carefully. See if they give guarantees. Note how long they have been in business and note the publications in which they advertise.

"THE WIRELESS AGE and most other good publications refuse to accept the advertisements of new and small concerns without being assured that the concerns are all right and will meet their obligations. If you have had any trouble receiving goods ordered, write us, and we will take up the complaint."

### SOME LETTERS RECEIVED

Sec. N. A. W. A., 450 4th Ave., N. Y. C.  
Rec'd \_\_\_\_\_ from \_\_\_\_\_ which I wrote you about and thank you for your trouble, one letter of yours being more effective than half a dozen of mine.

GILBERT E. MAUL, Chatham, N. J.

Sec. N. A. W. A.  
I received the equipment. \_\_\_\_\_ Thank you for

**It Pays to Be a Member of the N. A. W. A.**

From July N. A. W. A. Monthly Service  
Bulletin.

"The item in our last bulletin about protection for members has called forth considerable correspondence. Assistance will be given members in every case. A considerable number of complaints against one small concern in New York City shows it to be the worst offender. It seems more than likely that with the accumulation of complaints and with the aid of the Post Office Inspectors that this particular concern will be compelled to make good. Practically all other concerns about which complaints were made have been found to be all right and we feel confident that the houses will straighten out claims when properly presented to them.

"We are glad to know that our members appreciate that this protection work is one of the tangible evidences of the value of membership in the N. A. W. A."

Since the publication of these notices the Secretary of the N. A. W. A. has received numerous complaints, most of them against two or three concerns. A small percentage were against houses of good repute and were due to clerical errors which were at once corrected when brought to the attention of the houses concerned. The bulk of the cases concerned irresponsible concerns doing business with apparatus of little or no value. Redress is practically hopeless. The only solution is by an accumulation of evidence by means of which the Post Office Department may find it possible to issue a fraud order which will put such concerns out of business. Send in your cases with full details. Many requests have been made that we publish the names of these houses. This we are unable to do until the evidence brings action on the part of some one to recover losses and damages.

your quickness in securing results.  
ROY MACKIN, San Francisco, Cal.

Sec. N. A. W. A.  
This morning received check from \_\_\_\_\_ in refund. Had written a dozen times but could get no results but one letter from you made them come across.

PHILIP BOST, Statesville, N. C.

# THE WIRELESS AGE



Owing to the fact that certain statements and expressions of opinion from correspondents and others appearing in these columns from time to time may be found to be the subject of controversy in scientific circles and in the courts, either now or in the future, and to sometimes involve questions of priority of invention and the comparative merits of apparatus employed in wireless signaling, the owners and publishers of this magazine positively and emphatically disclaim any privity or responsibility for any statements of opinion or partisan expressions if such should at any time appear herein.



MARCH, 1917

# Dangers of the Proposed New Radio Bill

Leading Authorities Point Out Harmful Features of Government Ownership—Private Enterprise Necessary for Development of Wireless Art—Proposed Measure Would Crush Amateur Enthusiasm—How Commercial Companies Encourage Inventors—Experimenters an Asset to Country—History of Wire Telegraphy and Telephony Cited to Prove Case in Point—New Legislation Not Needed—This is Proved by the Offer of the Marconi Company to Turn Its Entire Enterprise Over to the Government in the Existing Crisis

**I**MMEDIATELY following the published announcement of the break in relations with Germany, Edward J. Nally, vice-president and general manager of the Marconi Wireless Telegraph Company of America, telegraphed to President Wilson, placing at the disposal of the Government, for use in any emergency, the entire organization and personnel of the company, including its high-power stations at Marion and Chatham, Cape Cod, Mass.; New Brunswick and Belmar, N. J.; Bolinas and Marshall, California, and Kahuku and Koko Head, Honolulu, Hawaii. Also the company's coastal stations, about sixty in number, located from the most northwesterly point on the Atlantic Coast to, and along the Gulf, and the entire Pacific Coast to Northern Alaska, and on the Great Lakes. Also the company's manufactories, workshops and trained staff, subject to the orders of any particular department of the Government which may need its services.

This occurrence took place practically a week after the closing of the hearings of a Committee of the House of Representatives on the proposed new bill to regulate radio communication, by the terms of which the Government would obtain control of the coast radio stations

and operate them in times of peace. The proponents of the measure, chief amongst whom were the heads of the Army and Navy Departments, seemed to be of the opinion that the safety of the country demanded that wireless telegraphy become a Government monopoly. The bill was opposed at the hearings, however, by the country's authoritative experts of the wireless art, who pointed out that a Government monopoly would inevitably crush the widespread encouragement wireless received from the enterprise of the commercial companies and the inventive enthusiasm of amateur experimenters. The heads and managers of the Marconi Company emphasized the detrimental features of the proposed measure, and called attention to the fact that the precautionary features of the bill were superfluous, since the company stood ready at all times to place the machinery of its wireless enterprise, including power stations, organization and factories, at the disposal of the Government in any time of crisis, disorder, war or threatened war that might arise. Their statements and assurances were justified by the facts, when the crisis arrived on February 3, and the offer of the Marconi Company was made and accepted, clearly proving

that Government control or Government ownership is not essential to the best interests of the Nation.

Leading wireless authorities gave their opinions at the hearings, and they coincided in the statement that the provisions of the bill, especially the one authorizing the taking over of the coastal stations of commercial companies by the Government, spelled an invasion of the existing commercial field, which would lead inevitably to Government ownership. This eventuality they asserted, would be harmful to the development of wireless telegraphy, in that commercial rivalry and private enterprise, through the investment of capital and the encouragement of invention and improvements, had been instrumental in advancing all means of human communication, as was proved in the history of the development of wire telegraphy and telephony.

Special emphasis was laid on the fact that the thousands of amateur wireless operators and experimenters throughout the country were an asset to the Government in their especial field, since they were responsible for many of the useful wireless innovations, represented a fertile field for the nation's inventive genius, and provided recruits for the Army and Navy in their important branches whenever a public need arose. And it was proved conclusively that the proposed bill would check amateur zeal and enterprise, since the rewards for the inventiveness of the amateurs came, not from the Government, but from the watchful business instinct of the commercial wireless organizations.

The Hon. John W. Griggs, president of the Marconi Company of America, at his appearance before the House Committee, analyzed the provisions of the bill and pointed out what their effect would be on the commercial companies. He reasoned clearly that the measure was decidedly unjust to the commercial companies, especially a great, beneficent enterprise such as the Marconi Company of America. He stated that for fifteen or sixteen years the Marconi Company had been operating to develop wireless and its business enterprise for the purpose of making a profit for its investors

"What danger is there to this country because Mr. Marconi is the vice-president of the company I represent? Will anybody suggest to me what danger there is to this country because one-third of the stock is owned by aliens either in Great Britain or Italy? The company is amenable to the laws of the United States. And with what face can the American Government, through its telegraph companies, go to foreign countries and ask for a concession to land its cables on their shores? The concession for the Western Union cable to Great Britain will expire in two or three years. Suppose the English Government says, when asked for the renewal of that right, 'Gentlemen, you do not allow any American company that has British stockholders to do business with you. You are an American company. We do not see fit to allow you to renew your concession.' Is that the kind of spirit that you wish to foster between the nations of the earth?"

—The Hon. John W. Griggs,  
President of the Marconi Company.

—the stockholders. "It has developed," said Mr. Griggs, "what is known as the ship to shore business, so that in connection with its manufacturing of apparatus which is carried on at its factory, it is making at the present time a trifling profit over and above its expenses but not enough to justify a dividend upon its stock. It manufactures apparatus of small capacity and leases it to ships of American registry that trade on the high seas, furnishes the ship with the operator, and gets a monthly rental for that. The law of Congress requires the ships to be equipped with wireless apparatus, and I think almost all of the American fleet on the Atlantic coast is equipped with Marconi apparatus. In order to render this apparatus more valuable to the lessees, the wireless company has established coastal stations at

various points from Maine to Texas. These stations serve not only as points of communication with ships going up and down the coast and in order to transmit intelligence to or receive intelligence from the mainland; but they also serve as supply depots for the Marconi Company. And the lessees of the apparatus, when they sign a contract, are assured by our company that with these stations at designated points along the coast, at any time they put into the ports where these stations are located, they can get any new parts for their apparatus which they may need, or they can get their apparatus repaired by one of our experts who is there on the ground for that purpose.

"There is an important international phase of the radio problem, the solving of which requires the development of extended control of equipment standards, operating practice and language qualifications. If the ships of the sea are to develop among themselves, and to the shore, universal intelligible communication, which is undoubtedly within the possibilities of radio development, a Government department, it will be admitted, can hardly be qualified to insist on the disciplining of an operator on a foreign ship who may be lax in duty or deficient in qualifications. There are daily possibilities here for the development of unpleasant and embarrassing international complications."—*Edward J. Nally, Vice-President and General Manager of the Marconi Company.*

Or if their operator has been disabled, has died, or from any other reason is disqualified, we can furnish them with another operator. So you see that the system of coastal communication stations, while there has been some suggestion here that they did not do a toll business with the ships that paid, is as indispensable to our plan of doing business as is any part of the plan. And I may say right here, now, that if the Navy

Department were alone allowed to carry on these coastal stations, they would not be able to provide supplies, make the repairs and furnish the additional operators which the Marconi Company does, and which it is a part of our contract to give the lessees of which I think there are now about 500 sailing the Atlantic from one port to another."

Mr. Griggs further asserted that it had been admitted at the hearings by Commander Todd and Captain Bullard, that the object of the bill was to coerce the Marconi Company into letting go of its business, particularly its coastal stations, and that the proposition was to give the Navy Department unlimited authority to do commercial business in competition with men who had put their money into a mercantile venture, and to so conduct the Government end of it that eventually, in five years, they would be glad to sell out.

"They have a provision in this bill," continued Mr. Griggs, "that is so directly aimed at the Marconi Company that I must think it was the bull's eye at which they were shooting. They say that no company shall be licensed, and if licensed, it shall lose its license to operate a wireless station, long distance or any other, if one-third of its stock is owned by aliens, or if any officer of the company is an alien. Will anybody suggest to me, gentlemen, what danger there is to this country because Mr. Marconi is the vice-president of the company I represent? Will anybody suggest to me what danger there is to this country because one-third of the stock is owned by aliens, either in Great Britain or Italy? The company is amenable to the laws of the United States. And with what face can the American Government, through its telegraph companies, go to foreign countries and ask for a concession to land its cables on their shores? The concession for the Western Union cable to Great Britain will expire in two or three years. Suppose the English Government says, when asked for the renewal of that right, 'Gentlemen, you do not allow any American company that has British stockholders to do business with you. You are an American company. We do not see fit to allow you to renew your

"Read the list, an enormous long list, of lives that have been saved from sinking ships at sea! The benefits to mankind and to the world, in saving property and life, of the Marconi Company, are enough for the Government, if it had a right to recognize those things, to give it an enormous bounty. Not only has this enterprise and this company done good to the world, but nobody comes with any charge against it of monopoly and oppression and misconduct."

—*The Hon. John W. Griggs, President of the Marconi Company.*

concession.' Is that the kind of spirit that you wish to foster between the nations of the earth?

"Read the list," exclaimed Mr. Griggs, "an enormous long list, of lives that have been saved from sinking ships at sea! The benefits to mankind and to the world, in saving property and life, of the Marconi Company, are enough for the Government, if it had a right to recognize those things, to give it an enormous bounty. Not only has this enterprise and this company done good to the world, but nobody comes with any charge against it of monopoly and oppression and misconduct.

"You are asked now to make in time of peace the Navy Department superior to the civil interests of the country, to the commercial and business interests. We think the law of 1912 affords adequate legislation as administered, and we do not think it ought to be modified or changed, except we are willing that Congress should make any provision they think is wise, so that in time of war or great emergency or tumult, the stations of a wireless company may be taken over by the Government, and all the employees sworn into the service of the Government. Or, we will go further if it can be worked out. We will agree that every operator in a station on American soil shall be sworn into the reserve service of the United States, so that he is bound to respond to any mili-

tary law when the exigency arises."

Similarly, Edward J. Nally, vice-president and general manager of the Marconi Company, drew upon his wealth of experience in calling attention to the dangers in Section 5 of the bill, which provides for the opening by the Government of its radio stations to general public business. He stated that if this provision were enacted into law, it would create a condition of competition between Government and private interests, resulting in a heavy financial loss to commercial companies, which have spent considerable sums of money and years of labor in the development of efficient radio stations, so as to provide a satisfactory commercial wireless-telegraph service to the public. Much had been said during the hearing, he continued, by proponents of the bill of the willingness, if not anxiety, of the commercial companies to dispose of their coastal stations to the Government. This was not true so far as the Marconi Company was concerned. By the expenditure of millions, it had erected and maintained land or coastal stations from the most northerly point on the Atlantic coast to the most southerly point on the Gulf, on the Great lakes, and on the Pacific coast to northerly Alaska. These stations represented the essential links in the ship and shore service, and the long list of rescues at sea and of lives and property saved because of the ready response which ships in distress at sea had been able to obtain by reason of the coastal stations, made a long and honorable record of which any company might be proud.

Mr. Nally impressed upon the House Committee the fact that this great service in the salvation of life and property had earned for wireless the right to be developed and made useful to the fullest possible extent, and such development could come only through private enterprise. It was impossible, he maintained, to formulate legislation which would foresee and provide for the future usefulness of radio communication. He referred to the telephone as a case in point, asking whether, if the Navy Department had been granted a monopoly of the telephone when that means of communication was first developed,

would the United States today have, as it has, the greatest telephonic development of any country?

"And yet," said Mr. Nally, "the telephone has not supplanted the telegraph. It occupies an entirely new field created for it by the persistence of private enterprise." Coastal stations were not money makers for the commercial companies, any more than the telephone exchanges or the great main operating rooms of the telegraph companies earned money for those concerns. But their function was to contribute the element that made the service complete and comprehensive. He added that the request to have the Government assume a monopoly of the commercial coast wireless business was not justified on any ground of military necessity, since the great countries of Europe, such as England and Germany, while making the most of radio possibilities, have left the development of the art to commercial companies, even assisting them with subsidies.

George S. De Sousa, traffic manager of the Marconi Company, testified before the Committee that no evidence had been produced by the supporters of the bill to show that the commercial companies had failed to conduct properly their commercial wireless telegraph business. He asserted on the contrary that he had proof showing that where the Government stations have attempted to handle commercial business, they have not done so as satisfactorily as the commercial stations, and that commercial operation by naval stations has proved far inferior to that of the purely commercial concerns.

David Sarnoff, commercial manager of the Marconi Company, spoke before the Committee on the subject of interference. This was not complained of by the commercial companies, he pointed out, but by naval operators, who, he asserted, were not as efficient operators as the commercial men. Another point which he emphasized was that when interference does occur, the majority of cases originate from ships, since there are more ship than coast stations, and the proposed bill does not touch on this question at all.

The chief advocates of the bill were Secretary Newton D. Baker, of the War

Department; and Secretary Josephus Daniels, of the Navy Department; their official communications definitely disclosed the fact that the bill was designed to invade the existing commercial field. Secretary Daniels strongly recommended that provision be made for the purchase of all stations used for commercial purposes, and he and Secretary Baker endorsed Government control for wireless. Commander D. W. Todd, U. S. N., testified that he believed in total enforced Government ownership and Captain W. H. G. Bullard, U. S. N., also warmly endorsed the measure, which he said was a result of deliberations of representatives of all departments of the Government.

One of the most effective witnesses before the Committee was Professor M. I. Pupin, professor of electro-mechanics at Columbia University and president of the Institute of Radio Engineers. Professor Pupin showed conclusively that development of the wireless art was dependent on individual enterprise, that it was the commercial companies alone that encouraged inventors and others re-

"How does the inventor feel with regard to the Army, and particularly the Navy—I mean the wireless inventor? If the Government owned the wireless, the men who are interested in the development of wireless would probably drop their interest in the subject. I may be wrong, but that is really my opinion.

"In the electromagnetic telephone we had interference between wires. We had cross talk, so that you could hear any number of people at once interfering with other people. And if the Government had owned the telephone wires, they would have simply legislated and would have determined that no telephone wires can be placed at a distance closer, say, than a hundred yards. This would have given a black eye to the telephone art."

—Professor M. I. Pupin, of Columbia University.

sponsible for the development and progress of the science, while such pioneers in the science were not alone not aided or encouraged by Government departments, but were absolutely despoiled of the fruits of their labor and genius by them.

"I came here to testify," said Professor Pupin, "for the purpose of demonstrating, if possible, that this bill would be most detrimental to the development of this young art—the wireless art — because it would inevitably lead to Government ownership. Now, it has been represented to you by the heads of our Government departments, namely by the Secretary of War, the Secretary of the Navy, the Secretary of Commerce, Commander Todd, and by other Government officials interested in the national defense, that the Government should control, in fact, that the Government should own, wireless telegraphy. Now I am interested in the national defense as much as anybody, and I am convinced that if

we are to use any art, and particularly the wireless art for the national defense, the best thing for us to do is to develop that art. If interferences exist, as has been pointed out in the several depositions here before you, on account of the present imperfection of the wireless art, then these interferences should be eliminated not by legislation but by perfection of the art.

"Take the ordinary telegraphy and telephony by wires. What was their experience in their early history? Exactly the same as we have in the wireless art. From 1845 to 1860 the men interested in the development of electromagnetic telegraphy, spent most of their

time in quarreling among themselves on the subject of how to get around the inductive disturbances.

"They had inductive disturbances just as much as we have today in wireless telegraphy, and they were of two different kinds: Inductive disturbances produced in a wire by the operation of other wires and inductive disturbances produced by God. Now what are these interferences which are produced by the acts of God? We did not realize them

"The Navy says, 'We are bothered by interference.' How much better is it for them to be bothered by interference in time of peace than to be bothered by interference in time of war. They say 'Let us have no interference now; let us be comfortable and happy; and let us communicate with each other and with our brother officers on each other's ships.' But when foreign cruisers come over here, will they listen to such proposals? What happened off South America when the English commander, Admiral Craddock, was defeated in that fight? His wireless was jammed by his opponents. If he had had a superior wireless system, he would have been free from all radio hindrance and interference from his enemies."

—Professor Arthur E. Kennelly, of Harvard University.

until electrotelegraphy was invented. And we never realized it to such an extent as we do today, since the wireless telegraphy was invented. Now, what is wireless telegraphy? It is communication between two points on the surface of the earth, or between a point on the surface of the earth and a point in the air, as in the case of the aeroplane, by means of electric oscillations. You create an electric oscillation at the sending station; that electric oscillation goes to the receiving apparatus and creates there an electric

oscillation which affects a receiving instrument.

"We know today that these electrical oscillations are produced in the atmosphere by God for purposes that are known to Him. Interference in wireless telegraphy due to static, due to the acts of God, is so serious that sometimes a wireless station cannot receive a message for 48 hours. For days in succession they cannot receive a thing. Not on account of interference of other stations but on account of the static, on account of the electric waves, the electric oscillations, which God sends from an infinite number of stations located anywhere in the atmosphere between the

North and South Poles. Now, these are the acts of God, and I do not see that these interferences have even been touched upon in all of these depositions. And these are the most serious interferences that we have, and you cannot get rid of them by any act of the legislature. The only way to get rid of them is by perfection in wireless, by the proper training and bringing up and perfection of this healthy, robust baby, which I call the wireless art.

"But the heads of the Government bureaus propose that this baby should be put into a Government institution. Now, it seems to me that would be almost a crime. We would suffer, the United States would suffer—the people of the United States, the Army and Navy would suffer. When it comes to getting rid of the interference produced by the acts of man through legislation, we can do that to a certain extent by legislation, provided we are legislating against the acts of our own citizens. But what legislation is going to prevent the enemy in time of war from interfering with us?"

"It is told by the English wireless operators who took part in the battle off the Falkland Islands that the Germans, as soon as the battle started, went up and down the scale of their wireless sparks for the purpose of making it impossible for the English ships belonging to that squadron to communicate with each other. Now I would like to know how any act of legislation, how any act of Government ownership, can prevent that!"

"If I had my own way I should perhaps proceed in a radical way. I should produce as many interferences as I possibly could, for the purpose of development of the art, so that no ingenuity of man could interfere with a wireless operator when he receives. And that is possible. Things are being done today by well-organized industrial research laboratories. Things are within the reach of those who are studying the situation which will transform the whole aspect of the wireless art. These things, I say, are being done because the Government does not own the wireless. And if the Government owned the wireless, they would not be done. I will tell you the reason why.

"I have proof showing that where the Government stations have attempted to handle commercial business they have not done so as satisfactorily as the commercial stations, and my experience in the wireless telegraph business, which dates over a period of thirteen years, has convinced me that commercial operation by naval stations in the past has been far inferior to the service rendered through commercial stations, and I have no hesitancy in stating that, should all commercial business be handled through Government stations, the service would suffer materially, to the detriment of shipping and the public in general."

—George S. De Sousa, *Traffic Manager of the Marconi Company.*

"I have the greatest respect for the Army and Navy. I have a great many friends among the officers of the Army and Navy, and I would not for the world do anything which would hurt their feelings. But we are here to be frank, open and aboveboard, and we must say what we think is right, what we think is best for the wireless art and for the people of the United States."

It was at this juncture that Professor Pupin introduced the case of a young wireless inventor, whose experiences, as between the commercial companies and the Navy Department, are an eloquent example of the handicaps that beset human endeavor. The members of the House Committee took a vivid interest in the recital of this young man's experiences, which are of deep concern, naturally, to every wireless amateur in the country. The inventor in question, Edwin H. Armstrong, subsequently gave his testimony before the Committee.

"How," asked Professor Pupin, "does the inventor feel with regard to the Army, and particularly the Navy—I mean the wireless inventor? I will describe it briefly for the purpose of explaining what I mean when I say that if the Government owned the wireless, the

men who are interested in the development of wireless would probably drop their interest in the subject. I may be wrong, but that is really my opinion.

"I refer now to a man who made a very beautiful invention. In 1910 Dr. Austin, director of the Wireless Research Bureau of the Army and Navy, and whose station is on the grounds of the Bureau of Standards, published a paper in which he compared the efficiency of various types of receivers. Among the receivers he examined was a new one, the so-called audion, the very audion receiver which is used today almost universally. Dr. Austin found that this audion was one and a half times as good as the best receiver they had prior to that time—one and a half times, mind you. At that time a young inventor, to whom I refer, was a student in Columbia University, a sophomore. That was in 1910. In 1912, when this student graduated, he got a patent—I do not know whether he got a patent that year, but he had the invention anyhow, a very simple thing, consisting in taking that audion tube and by a simple transposition of the circuits, making it 5,000 times as sensitive as the one which Dr. Austin examined. With what result? With the result that everybody is using it today and all the operating companies pay this young man

"It is known by all radio men—and I think if they will speak frankly and sincerely, they will bear me out—that the Navy operators are not anywhere near as efficient as the commercial operators. The men in the Navy Department receive their positions by assignment. They have to take an electrical course, and I am not deprecating the value of electrical knowledge, but when a man is a wireless operator, I say he must be a good wireless operator and not primarily a good electrician. Most of the Navy operators are electricians rather than telegraph men."

—David Sarnoff, *Commercial Manager of the Marconi Company.*

a modest royalty. They cannot afford to pay more than a very modest royalty. But it enables this young man to support his mother and two sisters. The United States Navy uses this invention more than anybody else. According to the information which an officer of the Navy gave to myself, they were using it since January, 1914. And they had it a year ago in something like forty stations. They have not paid a cent to this young man, and they do not intend to. They all tell him, 'You can go to the Court of Claims.'"

Joshua W. Alexander, chairman of the Committee, interrupted the speaker for a moment to inquire whether this action of the Navy department was due to the fact that anyone was contesting the right to the invention. Professor Pupin replied that the right was not contested and the best proof that the invention was valid lay in the fact that the wireless operating companies were paying the inventor a royalty. The latter, however, did not have the means to go to the Court of Claims and press an infringement suit, and his lawyer had advised him against such action, since he would spend all he had and would not know when he could get any returns.

Continuing his discussion of "interference," Professor Pupin said: "In the electromagnetic telephone we had interference between wires. We had cross talk, so that you could hear any number of people at once interfering with other people. And if the Government had owned the telephone wires, they would have simply legislated and would have determined that no telephone wires can be placed at a distance closer, say, than a hundred yards. This would have given a black eye to the development of the telephone art. To day we use inside of a sheathing 600 definite circuits, and we can have 600 different people talking at the same time through these circuits without any cross talk; without any interference at all, whereas if the Government had owned that art from 1876 to 1895, or 1900, we would have had to separate those wires and the art would have never reached that point where it can have in a small space 600 different circuits. That would have been impossible.

"There are certain paragraphs in this bill which we believe will change the status of the amateur, or at least are susceptible of changing the status of the amateur. We would be at the mercy of the Department of Commerce in the administration of the law.

"Now the members of our association have no objection whatever, because they are all patriotic citizens, I am sure, to closing their stations in time of threatened war or public disaster or any similar situation. But any station in our judgment could be closed for successive periods of five years and no redress is provided in the bill."

—Charles H. Stewart, of the Wireless Association of Pennsylvania.

"Now if the Government means to take possession of wireless and establish industrial research laboratories and go into the art of manufacture—because that is the only way that you can develop an art—to manufacture yourself and not have somebody else manufacture it for you—then well and good. Then perhaps this bill would have some meaning. But this bill as it stands, with the other conditions—with the other laws and the other historical conditions of Government work existing—this bill means nothing else than a blow to this wonderful art of wireless telegraphy. It does not provide for Government ownership but inevitably leads to it, and the Secretary of War and the Secretary of the Navy and Commander Todd—they all say that it will lead to, and they want it to lead to Government ownership."

Professor Pupin told the Committee that the young inventor to whom he had referred would appear before them and present the facts. As stated, Mr. Armstrong eventually gave his testimony to the Committee. He said that he had invented the regenerative audion receiver, which was the best interference preventer known at the present time, being used throughout the world in commercial and

Government stations.

"My particular interest in this legislation," said Mr. Armstrong, "began several months ago, when I was asked by one of the Government inspectors at the port of New York to investigate the question of interference between the Wanamaker station and the Brooklyn Navy Yard, when the Brooklyn Navy Yard was receiving signals from Arlington. Now the conditions of that service are these: The Brooklyn Navy Yard is two miles from the Wanamaker station. They desire to receive signals and messages from Arlington, which is 200 miles away from the Brooklyn Navy Yard. The Arlington station operates on 2,300 meters, the Wanamaker station on 1,800 meters. That is a difference of wavelength of 25 per cent. The power of Arlington and the power of the Wanamaker stations are of the same order. The Brooklyn Navy Yard station cannot receive from Arlington, while the Wanamaker station is transmitting. That is an established fact. The Government inspectors of the port of New York know that, because the Navy has complained of the interference of the Wanamaker station."

Mr. Armstrong related how he had duplicated the conditions under which the Brooklyn naval station was working and set up some amateur apparatus and received messages from Arlington, while the Wanamaker station was sending, without the slightest interference. He then told the story of his negotiations with Government officials regarding the right for the use of his invention. He said that he had met Lieutenant Commander Hooper in Washington, who told him that the department did not pretend to know anything about patents. He received an offer for royalty on the few sets of apparatus which the Government manufactured themselves, but the Government officials refused absolutely to pay any royalty on the use of the apparatus, whether it was manufactured by the Government or by infringing manufacturers. Mr. Armstrong added:

"As I understand it, the length of time which it takes to get a case through the Court of Claims and the length of time which will elapse between the time the

Court of Claims rules and the time the money is appropriated by Congress is such that the ordinary inventor will starve before he can get any relief."

Among the most effective opponents of the measure was Professor Arthur E. Kennelly, of Harvard University, vice-president of the National Amateur Wireless Association, whose reasoning was along practically the same lines as those of Professor Pupin. "I am here," he said, "to urge my contentions that this bill should not be passed for a variety

of reasons. In the first place, if there is one thing of which this country ought to be proud, it is that it has taken such a shining position in the world in regard to telephonic communication. I do not mean radio telephonic communication, because that is a very young art, although it is coming along; but I mean telephonic communication generally. It was this country that first established communication with France by telephone and with Honolulu by telephone, and there is no other country in the world that has any such

telephonic record. And that has been accomplished because the telephonic art in America has been fostered and developed under free institutions and not under Government control. In those countries of the world where there is Government control of the telephone and telegraph, you will find them in a relatively backward state.

"The Navy says, 'We are bothered by interference. How much better is it for them to be bothered by interference in time of peace than to be bothered by interference in time of war. They say, 'Let us have no interference now; let us be comfortable and happy; and let us communicate with each other and with

our brother officers on each other's ships.' But when foreign cruisers come over here, will they listen to such proposals? What happened off South America when the English commander, Admiral Craddock, was defeated in that fight? His wireless was jammed by his opponents. If he had had a superior wireless system, he would have been free from all radio hindrance and interference from his enemies. Now what we must have, for the sake of ourselves and the Navy, for the sake of all of us, is a system which will

be free from interference. And you are going to produce a system which will be free from interference by saying in time of peace that there shall be no attempt at interference? It is easy to have no interference where a monopoly exists.

"I can remember, and I dare say my friends here remember, the early days of the telephone. You could not talk to your neighbor without hearing all the neighborhood. And that was a growing trouble. It was the haunting problem day and night of the tele-

phone engineers—"What shall we do to get rid of this eternal eavesdropping of the world? It has been now so thoroughly eliminated you could hardly realize, from using the telephone today that there had ever been such a period. Why? Inventors came forward, all the brightest minds in the telephone art were stimulated to do something to overcome this difficulty.

"We want the Navy to be strengthened. It cannot be strengthened in this way. The right way to do is to have the Institute of Radio Engineers and a lot of bright lads all over the country working on these problems and coming forward and offering various means for

"There has been some complaint made about the amateur operators interfering with Government stations. If the amateur had as much interference as I have heard referred to here, I think we ought to drop out of the business. It is nothing for me to sit and hear a couple of little boys—they call them kids—chirping with a couple of little kilowatts a great distance away. I can even hear the League Island calling out 'Q R T,' which means 'shut up,' and 'Q R T X,' which means to 'get out of that.' Now if a little kid with a 1/6-kilowatt transformer can get in touch with the Navy Yard, believe me, I would like to see the Navy Yard talk."

—Frank B. Chambers, of the Wireless Association of Pennsylvania.

preventing interference, and saying, 'I have a new scheme.' If it will serve, reward the inventor by giving him encouragement. But if you attempt to do away with interference under the proposed régime, you would stifle that enthusiasm absolutely."

Professor Kennelly pleaded with the members of the Committee for the encouragement of amateurs. "You can have this little army of amateurs," he said, "all over the country, listening in with their little wireless stations and hearing the pulse beats of the world, as it were. All these young men are thinking, and some of them will discover something which will be of benefit.

"I want to speak on behalf of the amateurs. It is not only the vested interests of the people who have put their savings into this enterprise for the benefit of the public; it is not only for the Navy, but it is on behalf generally of the amateurs of the country, for the young fellow who wants to communicate with his neighbors and utilize the atmosphere of the world—the circumambient ether, as it is called. It is he that I am thinking of; you will suppress him, too. So soon as you have scrapped and suppressed the commercial stations, you will still be bothered in the antiquated system in undisputed control of the Navy that no longer has interference from power stations—it will still be bothered by this man here and this little amateur there, and some officer will say he cannot get rid of that interference or that, when 'John Smith is talking in Washington we cannot hear ourselves talking in New

"After my patent issued, I received a communication from the Bureau of Steam Navigation stating that the bureau was informed that I was the inventor of a certain form of feedback circuit, and they requested information as to what steps they should take to secure the rights to use that invention. I went to Washington and met Lieut.-Commander Hooper. He told me that the department did not pretend to know anything about patents. He said it was the policy of the department, if possible, to settle claims of inventors. Then we talked business. I found that the policy of settling with the inventor was to offer him a royalty on the few sets of apparatus which the Government manufactured themselves. They refused absolutely to pay any royalty on the use of the apparatus, whether it was manufactured by the Government or by infringing manufacturers."—*Edwin H. Armstrong, Electrical Engineer and Wireless Inventor.*

York.' And so they will appeal again to Congress to stop the amateur, and there will be no use of the circumambient ether except such as the Navy department or some department of the Government wants."

Able representatives of the amateur wireless operators appeared in the person of Charles H. Stewart, of St. David's, Pa., and Frank B. Chambers, both of whom spoke on behalf of the Wireless Association of Pennsylvania, and also by special request of the radio associations of Germantown, the South Jersey Radio Association, of Collingwood, and the Atlantic City Association. These gentlemen protested vehemently against the bill as being detrimental to the best interests of wireless development, in that it would check the widespread and diversified work done by amateur investigators, whose encouragement would be ended could they not hope to obtain suitable rewards for their labors in behalf of scientific and technical advancement.

"There are a number of men," said Mr. Stewart, "belonging to these various associations that I represent, who are interested in this bill, because for a number of years past they have been operating stations in an amateur way. A great many of them have since graduated from the amateur ranks, some into the ranks of the Marconi Company and some in other lines of similar endeavor. Our association is somewhat at sea regarding this proposed legislation, in view of the fact that Commander Todd stated in the early part of the hearings that in

no way was the status of the amateur affected by this bill. If we could agree with him in that particular, of course, we would be satisfied. However, there are certain paragraphs in this bill which we believe will change the status of the amateur, or at least are susceptible of changing the status of the amateur. We would be at the mercy of the Department of Commerce in the administration of the law. I refer particularly to section 14b, which provides for the closing of stations for periods of five months and successive periods of five months, without limit, entirely upon the discretion of the President in time of peace. Now the members of our association have no objection whatever, because they are all patriotic citizens, I am sure, to closing their stations in time of threatened war or public disaster or any similar situation. But the unlimited nature of this paragraph is such that any station in our judgment could be closed for successive periods of five years and no redress is provided in the bill. The question of compensation for the taking over of our stations is one that we had not considered necessary to think about, because in time of war there is no question, I feel sure, that practically all of our members would be a unit in coming forward and helping the Government in every way possible. And remember, gentlemen, that there will be a number of field activities in war time in which we will be needed, for instance, in aeroplane work and Army work and activities of that kind. Remember, also, that the commercial operator is a good Army buzzer and he can jump right into those positions in time of emergency, where there is an absolute need of efficient men in the Signal Corps forces. There are sufficient men in our organization to take care of any army of any size."

Mr. Stewart expressed the conviction that the natural enthusiasm of the amateur was absolutely necessary for the service. "I think," he added, "some of the managers of the Marconi Company know that to be a fact. Now as I understand, there was a letter read before the Committee by Mr. Maxim, of Hartford, Conn. Mr. Maxim is well known, and I believe he approves this

bill, but he does not in any way represent the amateurs of our district. I confess I can not understand his attitude in favoring the bill, because of the possibilities. He may have some reason for favoring the bill which is not apparent to me. That is all I have to say."

Mr. Chambers, who appeared before the House Committee, said that he felt that if the commercial companies were put out of the field, the amateurs would lose interest. "If it had not been for the commercial companies in the first place," he asserted, "I doubt very much whether any amateur would have been interested at all. I do not think there would have been many amateurs. The amateur will exist only as long as there is something to be accomplished. The same was true of wire telegraphy when it was first invented. A great many men put up wires from one house to another to see if they could talk to each other and see who could do it best. As soon as the commercial wire telegraph companies arrived at a satisfactory condition, the amateur end of it fell off, and they went to work for these companies.

"I have been interested in playing with wireless sparks for about twelve years. I guess I am familiar with a great deal of the wireless apparatus that is being used to-day. There has been some complaint made about the amateur operators interfering with Government stations. If the amateur had as much interference as I have heard referred to here, I think we ought to drop out of business. It is nothing for me to sit and hear a couple of little boys—they call them kids—chirping with a couple of little kilowatts a great distance away. I can even hear the League Island calling out 'Q.R.T.' which means 'shut up,' and 'Q.R.T.X.' which means to 'get out of that.' The little kids have only a narrow field in which to work. I have heard the kids saying that they had caught the navy yard apparatus, and when I called up the navy yard to tell them about it, they would say they did not hear it. Now, if a little kid with a 1/6-kilowatt transformer can get



in touch with the navy yard, believe me, I would like to see the navy yard talk. I can go into Philadelphia and pick you out some little boys, between fourteen and eighteen, who are not operators at all; at least they do not know they are operators, but they are. Most of them make their own apparatus. A lot of them find old junk around the house and put it together to make their sets with. I know some of them have made the sliders on their tuning coil out of a tomato can, and their sliding rods out of strips from stairways. If you could see some of that apparatus you would have asked what it was all for. It does not look like electrical apparatus. It looks as though, in house-cleaning time, mother had found a lot of stuff around the house and concluded that it was nothing and threw it aside, and it landed on the table, and the boys had got some wiring and made an apparatus out of it. Those little fellows can sit down there and do work that surprises the men.

"How about when the navies of foreign countries come over here to our shores? Are they coming over with one-quarter kilowatts or two kilowatts? No. They are going to come over here in great big battleships with 6-kilowatt and 10-kilowatt apparatus, such as the British ships have been using right here in our waters. And suppose they come to our land stations, what is going to happen to our apparatus? Why, gentlemen, these complaints are ridiculous!

"I do not know where the fault lies. It is either with the apparatus or the operators. I know a fellow who was working with the Marconi Company, and he got fired. I asked him, 'What did you get fired for?' He said, 'I could not get the stuff.' Now a fellow reports to the Marconi Company that he could not get his message because the navy or an amateur or a couple of kids interfered with, his work and says, 'Well, I did not do much this week; too much interference.' He is fired. That is the end of him. I do not believe they would let him live a week on the job.

"Of course, that is the amateur way of looking at it. They talk about this amateur business. Let the inventors go along and make all the money they can. If the navy yard fellow will only get busy and get a little buzzer and practice up on this interference proposition, we ought to be able to get back at these Marconi men. That is all I have got to say."

Hiram Percy Maxim, whose endorsement of the bill occasioned such surprised comment by the representatives of large amateur organizations, is himself president of the American Radio Relay League. In his letter to the Committee he stated that he had carefully considered the proposed radio bill and desired to go on record as approving those parts which concerned amateurs, because he believed their enactment into law would reduce radio interference.

"The American Radio Relay League, of which I am president," wrote Mr. Maxim, "is an organization of approximately 5,000 amateur radio station owners scattered in all the states of the Union. I recognize that the proposed bill will confer greater powers upon the Navy Department, Department of Commerce, and upon the President in dealing with us amateurs; but I believe these greater powers will help our work rather than retard it. These authorities can not but appreciate that it is from the ranks of us so-called amateurs that the talent necessary to carry on both Government and commercial radio work is principally drawn; that we amateurs and the many manufacturers whom we support have been the source of several valuable improvements in radio science, and that in time of public need our well-organized relay trunk lines and our very efficient stations in the various states of the Union might easily be of incalculable value to our country."

Mr. Maxim's approval of the bill and his belief that it will be of service to wireless work are inconsistent, in view of the testimony of distinguished expert authority that the taking over by the Government of the commercial

stations would lessen the future usefulness of the commercial companies, and the enthusiasm of amateurs in wireless. Mr. Maxim states that he represents practically 5,000 amateurs, but available information shows that the membership of the League does not begin to approximate that number, and it is public knowledge that the National Amateur Wireless Association is stronger than all other amateur organizations combined. He does not say who these 5,000 members are; but they certainly are not members of the League.

On the whole, a review of the testimony delivered before the Committee

would seem to indicate that the experts and the commercial men had the better of the proponents of the measure. They demonstrated conclusively that the proposed bill has within it the seeds of radical and untried steps; that it embraces features which have not won the approval of the public, such as Government ownership and confiscation of private property. One of the most telling features of the testimony advanced lay in the acknowledgment that private business enterprise and amateur enthusiasm would be eliminated from the wireless field should the proposed measure eventually become a law.

VESSELS RECENTLY EQUIPPED WITH MAR CONI APPARATUS

Names	Owners	Call Letters
Freeport Sulphur No. 2	Freeport Sulphur Transportation Co.	KRG
Santa Rosa	W. R. Grace & Co.	WBO
Tug John Scully	Scully Line, Inc.	KVT
Holden Evans		(Not yet assigned)
Southerner	Southland Steamship Co.	KJH
Sherman	Chile Exploration Co.	KMQ
Maui	Matson Navigation Co.	WMR
Iquitos	Rocco & Miller	OBY
Joaquim Mumbru		ECX
United States	Colonel E. H. R. Green.	KZU
Winterswyk		PIS

THE SHARE MARKET

New York, February 7.  
 Bid and asked quotations in Marconi shares today:  
 American, 2 $\frac{5}{8}$ -3; Canadian, 1 $\frac{7}{8}$ -2 $\frac{1}{4}$ ; English, common, 12-16; English, preferred, 11-15.

The furthest north radio station on American soil now open and doing business, according to a newspaper report, is operated under the auspices of the federal bureau of education at Norvik, on the Kobuk river.

It is reported that the bureau of education has under consideration the erection of another wireless station at Barrow.

TACOMA'S GIRL OPERATOR

The first girl or woman in the Northwest to receive a Federal wireless operating license is little Miss Winnifred Dow, of Tacoma, who is also said to be the second of the feminine sex on the Pacific Coast to receive such a permit.

Miss Dow is fourteen year's old, and a student at the Visitation Academy. She constructed nearly all of her own wireless set, and expects to build a transformer that will give her station a long sending radius.

A dispatch from Salonica says the Greek Government has constructed hastily a wireless station at Larissa, and is in communication in code with Berlin.

# The Wireless Storm Detector

Its Influence Upon the  
Operation of Light-  
ing Central Stations

By W. H. Lawrence, Su-  
perintendent Waterside  
Stations, New York Edi-  
son Company

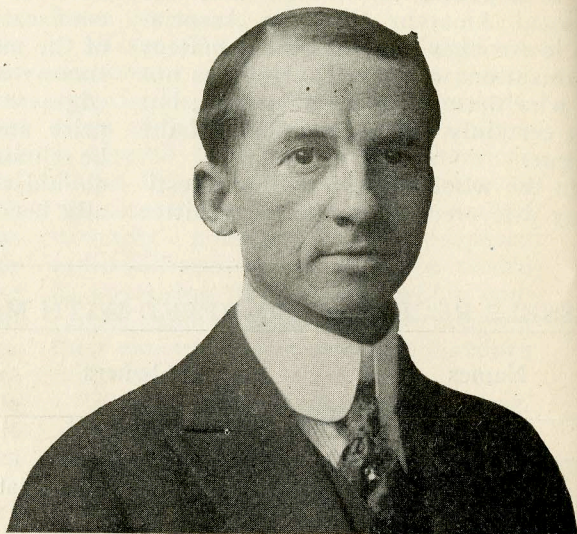

W. H. Lawrence

Note: Unexpected overloads have always been a source of danger to central station apparatus and sudden storms have embarrassed central station engineers to such an extent that some of the largest lighting stations keep a man posted on the roof to give warning of their approach. In this article from the General Electric Review the author, after citing the load conditions in the New York Edison stations, describes a most ingenious storm detector used by that company. The simplicity of construction and the effectiveness of operation are two notable features of this device which employs the principles of wireless telegraphy.

SUCH public utilities as those supplying gas and water are fortunate in that the commodities they distribute are physical materials. During those parts of the day when the demand for their product is small, the excess delivered from the station can be economically stored in a reservoir for use at later periods in the day when the demand is greater than the capacity of the station.

The public utility that distributes electricity, however, cannot be modeled profitably after this plan on account of the properties of the commodity that it handles.

Electricity, like light and sound, is not a physical material and therefore can exist only as long as the influence of its generating source continues. This property renders it impossible to directly store or preserve electricity for future use. Although such an end may be indirectly accomplished by the use of storage cells, which convert the kinetic energy carried by the current into potential chemical energy and later carry out the reconversion, the efficiency of this method is very low. For this reason, the use of storage batteries in supplementing the generation of electricity has been restricted to such purposes as involve the

economically avail themselves of the use of a reservoir which may be charged with the excess energy of the station at light load periods and discharged to assist the station at the heavy load periods, have to be designed with a capacity equal to no less than the maximum demand upon them. This factor of an installed station capacity at least equal to the maximum peak load is the greatest financial handicap to which an electrical station is subjected. That this condition is

the peak occurs lies between the hours of the winter and the summer peak.)

Since it is only during the peak load of the day that the whole equipment of the station is working, it is evident that the return on the entire investment during the remainder of the day must be earned by that portion of the equipment that is then operating.

This is a condition that makes it highly imperative that an electrical station be operated with maximum economy

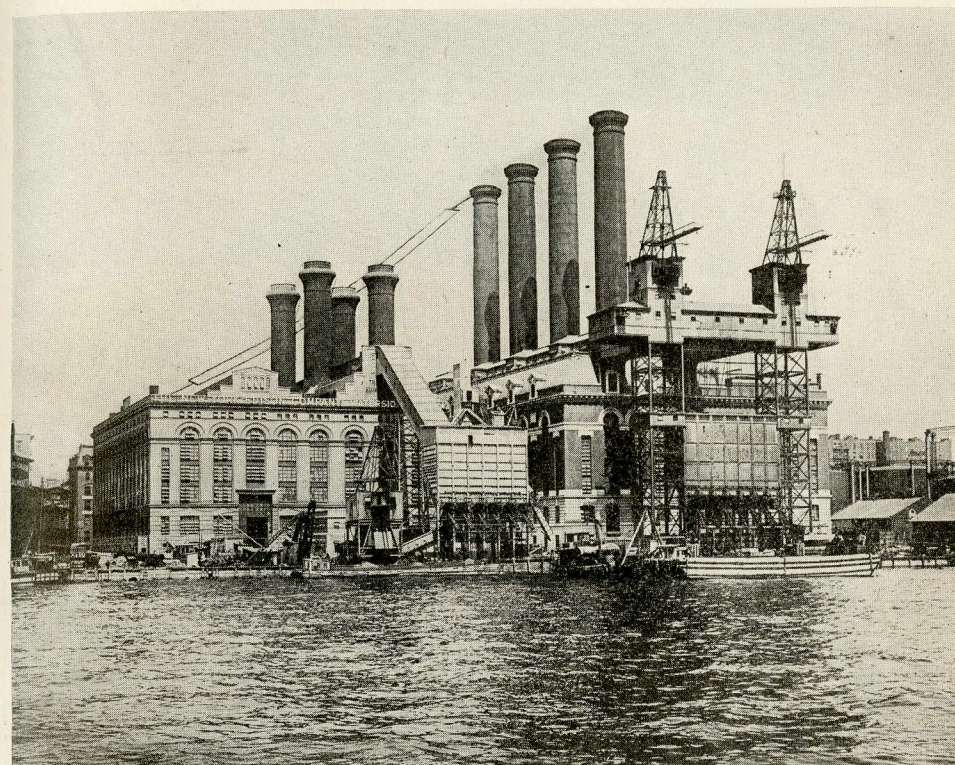

Waterside stations of the New York Edison Company with aerial indicated

unavoidable has long been recognized and accepted by our business men and engineers.

The variations in the load which are demanded of a lighting station during the day and the characteristic difference between the summer and winter loads are shown by Figures 1 and 2, in which Figure 1 is a typical load curve for a summer day and Figure 2 one for a winter day. (A typical load curve for the month of March is shown in Figure 3. It will be noted that the time at which

throughout the entire day. Given a certain station equipment, this is mainly accomplished by a strict adherence to a regular daily routine. Thus, at any period of the day only that number of machines is operated which is sufficient to economically carry the load then existing. At times of light load or average load, a steam-driven station will have a large share of its boilers "banked" and a number of its generating units idle. When under such a condition a large unexpected demand for an increased output may

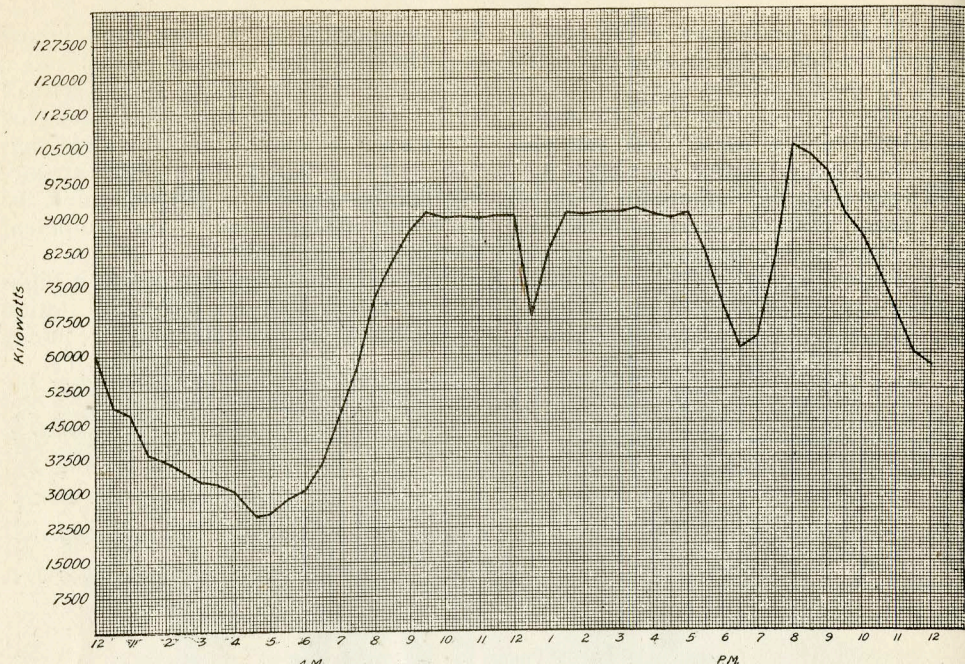

Figure 1.—A typical load curve of a lighting central station for a normal summer day (1913)

furnishing of a reserve to safeguard the service against interruption when some accident temporarily affects the generat- ing, transmission or transforming systems. Electrical stations, being unable to eco-

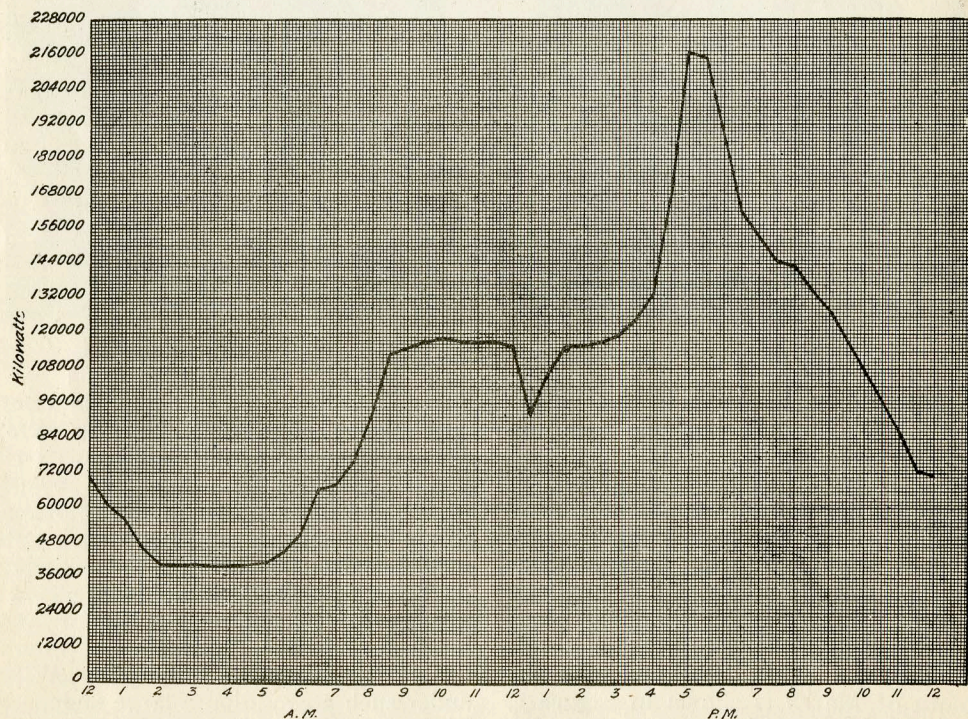

Figure 2.—A typical load curve of a lighting central station for a normal winter day (1913)

be made so suddenly that the number of machines which are operating will be insufficient to carry the abnormal demand, and it is probable that the standard of service will be lowered until such time as reserve boilers and generating units can be brought into service. For this reason it is imperative that the station receives preparatory warning of any abnormal demand.

The rapidly moving clouds which accompany a storm constitute the principal cause for the sudden and unexpected increases in the demand for current from a lighting station. The effect which a sudden and heavy storm may have upon the station's output is shown by the sharp peak at the 3:35 p. m. point of the curve in Figure 4. This is a record of an actual occurrence which took place during the month of March, 1911. It will be noted from this curve, and by a comparison with that of Figure 3, that the demand at 3:35 p. m. is 73 per cent. greater than it would have been had there been no storm. An increase of 49,500 k. w., in this instance, was called for in about 5 minutes, which gives a good idea of the severe demands that may arise and which a lighting station must be prepared to meet.

Any device, therefore, that will provide a warning of the approach of a storm, at a time sufficiently far in advance to enable the station attendants to prepare for the exception to their daily routine in a deliberate and orderly manner, would be most welcome.

The storm detector is such a device. All summer storms, or practically all of them, are accompanied by electrical disturbances in the ether. These cover a field far greater than that over which the storm clouds themselves are visible. By use of antennæ, some of these radiations may be intercepted and by a suitable apparatus be made to give an indication of not only the presence but also the relative proximity of the storm.

The storms that occur during the winter months are usually snowstorms and are of but a weak electrical nature. For this reason, they may perhaps not affect the device. At this season, that is a matter of but small moment. In winter, the load upon the stations during the

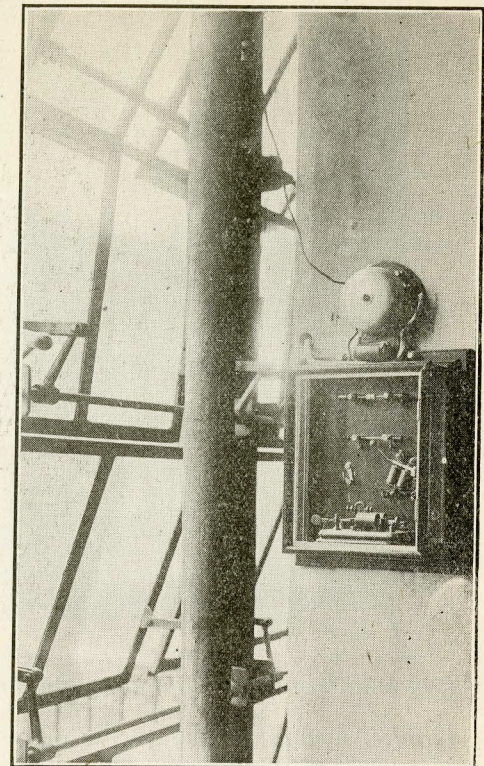

Receiving apparatus of the wireless storm detector

daylight hours is uniformly greater than during the summer and the demand regardless of the severity of the storm will always be from 20 to 25 per cent. less than the demand which occurs daily between 5 and 5:30 p. m., for which the station is always prepared.

This is evident when it is considered that winter storms have no effect on street lighting and other outside lighting, sign lighting, residence and apartment-house lighting, etc., all of which are on at the time of the daily peak at 5:00 p. m. For this reason, winter storms are of such minor importance that the service of the storm detector is dispensed with during that season.

The various parts making up the detector are an aerial, a short-circuiting switch, a spark gap, a coherer, a relay and battery, a bell (which also acts as a decoherer) and battery, a condenser, and a ground connections. Figure 5 shows the diagram of connection of these parts.

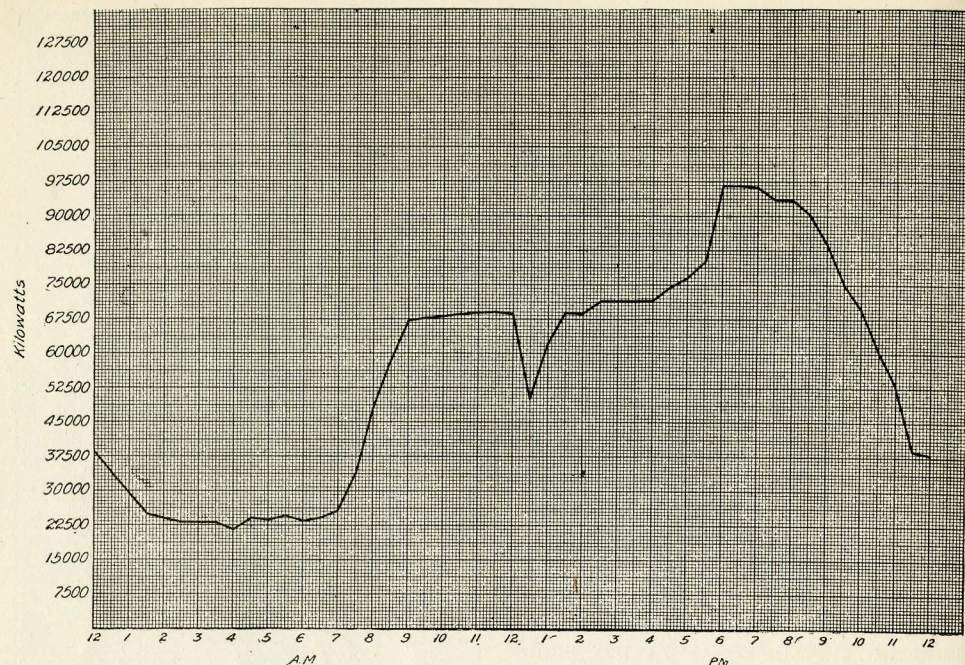

Figure 3.—A typical load curve of a lighting central station for a normal March day (1911)

*Aerial:* Antennæ, similar to the more wireless telegraph outfits, have been simple ones used in connection with found to serve the purpose admirably. It

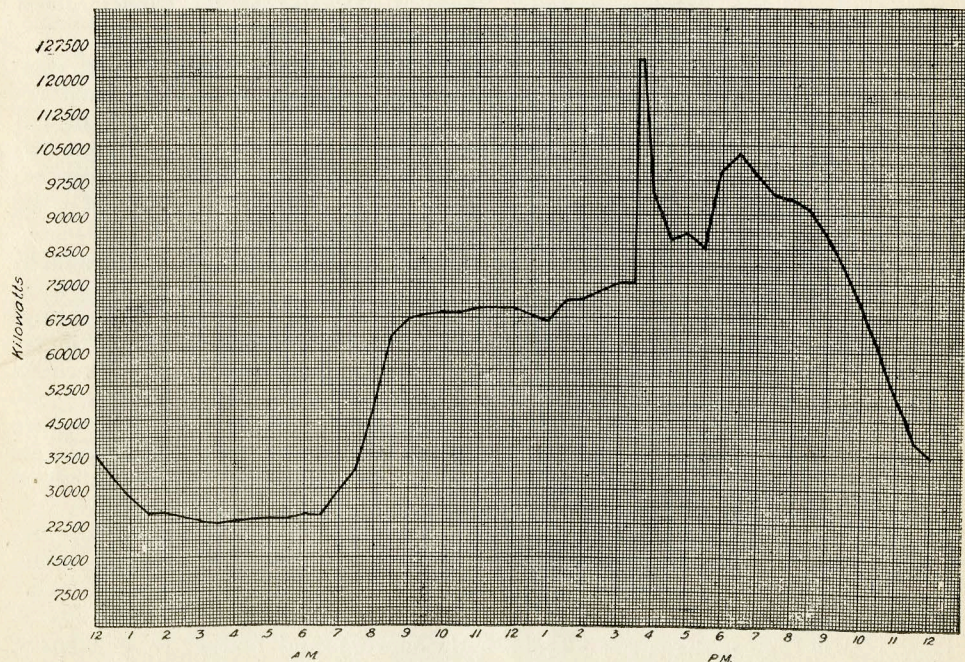

Figure 4.—An example of a load curve of a lighting central station for a March day (1911) during which a severe unexpected storm took place at 3:30 P. M. But for the abnormal peak occurring because of this storm, the curve would be similar to that of Figure 3.

is this part of the equipment that receives the ether radiations resulting from the storm.

The oscillating current thus set up travels to and from the ground through the spark gap, coherer, and condenser.

*Short-Circuiting Switch:* This switch and its connections are shown in Figure 5. Nominally, it is kept in the "open" position. After the alarm bell has begun to ring continuously, it is closed to protect the apparatus from heavy surges and to silence the bell.

*Spark Gap:* This consists of a simple gap with spherical terminals placed approximately 1/64 inch apart. The purpose of this gap is to prevent those surges that are induced in the antennæ by the radiations emanating from wireless telegraph stations, but which are very weak as compared to the lighting disturbances, from flowing through the remainder of the apparatus and thus causing a false alarm.

*Coherer:* This is also patterned after the type of the simple ones used in the early days of wireless telegraphy. In brief, it consists of a short section of glass tube of small bore loosely filled with nickel-silver filings. These are connected at each end to the outside circuit by German-silver plugs. The action of such a type of coherer is well known and needs no further explanation than to say that it acts as a high resistance to the low-voltage battery current impressed upon it until a high-frequency discharge current, between aerial and ground, has passed through it. This high-frequency current effectively lowers the coherer's resistance to the battery current, which consequently allows a greatly increased battery current to flow through the tube. The resistance of the tube then remains unchanged until it is violently jarred, at which time the high-resistance property returns.

*Relay and Battery:* The most effective type of alarm is an audible one, of which the simplest form is a bell. However, as a bell requires a greater amount of current for its operation than that increased amount of battery current which is caused to flow in the coherer by a high-frequency discharge, some magnifying or relay device must be used.

The relay employed is one of the ordinary telegraph type and the battery B<sub>1</sub>, Figure 5, is of dry cells. The connections are given in Figure 5.

*Bell and Battery:* The bell is one employing single-stroke connections and is of a size sufficient to be easily heard throughout the system operator's office. (The coherer, relay, condenser and bell are located in this office.) The bell has its own supply battery of dry cells, B<sub>2</sub>, and is controlled by the secondary contacts of the relay, as shown in Figure 5.

As the low-resistance condition into which the coherer is thrown by a high-frequency discharge is permanent until the tube is severely jarred, the bell is mounted so that its clapper will strike the tube and thus perform the two-fold function of bell and decoherer. (It is evident that the tube must be decohered, otherwise it would not show the effect of a later high-frequency discharge.)

*Condenser:* The condenser is an ordinary one and is inserted in the ground wire to prevent stray direct current from flowing in the apparatus.

*Ground Connection:* This connection completes the high-frequency circuit from aerial to ground.

The operation of the apparatus comprising the storm detector leaves practically nothing to be desired. The manner in which it enters into the activities of a steam station will be described, as it is perhaps to such a station that it is of the most benefit.

It will be remembered that the bell or decoherer, together with the coherer and relay, are located in the system operator's office.

It is the duty of the system operator that he keep continuously posted on the demands that are or may be made upon the station for power and to so direct the disposal of all the generating machinery that the station will afford the highest quality of service and will operate with the maximum degree of economy. In detail, the latter function he performs by orders to the boiler room specifying how many boilers shall be maintained under load and how many shall be carried "banked," by instructions to the generating room as to which machines shall carry the load and which other units

and auxiliaries shall be held idle or in readiness, and by orders to the various switchboard operators as to which feeders shall be used in the disposition of the output.

Under the usual daily conditions of operation the demand which will be made upon the station from hour to hour is accurately known, for the variations of the load curve constitute a daily cycle. These regular changes of load, being anticipated and taken care of by orders from the system operator, become a matter of station routine.

In order to secure smoothness of plant operation, the system operator is informed of the unusual departures from the regular load curve that are to be expected, *e. g.*, exhibition lighting, etc., and also of the weather forecasts. All such is of great assistance in aiding good management. Those unusual irregularities of whose coming he is reliably warned present no difficulties. It has been found by operating experience, however, that the weather forecasts come far from providing a reliable and early warning. Further, the reports are not couched in such terms as furnish the system operator with the information that is of paramount importance to him, *viz.*, the rapidity, in hours, of the approach of the storm.

It is true that the number of severe storms which come over a city with extreme rapidity is much less than that of the slower moving storms, but, on account of their tremendous capacity for suddenly deranging the orderly routine of the lighting station and perhaps even affecting the standard of its service, the fast moving storms make it requisite that all are to be guarded against.

Assume, for instance, such a storm to be approaching a city in which is located a lighting station that possesses a storm detector.

At a time varying from 2 hours to 7 hours before the actual storm clouds reach the city (depending upon whether the path of the storm is a direct or a round-about one), the alarm bell will begin to strike at intervals of from 5 to 15 minutes. The system operator regards this merely as the warning of the possible approach of a storm but gives

it no further attention, for the storm may change its direction and pass off without molesting the quiet weather conditions of the city.

The disturbing conditions by their further approach cause the bell to ring oftener. With the storm but about two hours' travel away, the bell will strike about once every half-minute or every minute. When this occurs the system operator orders the reserve boilers into service, the auxiliaries of such generating units as he deems may be required

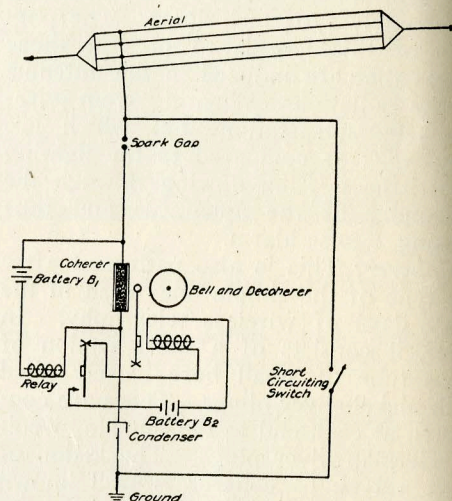

Figure 5.—Complete diagram of connections of the apparatus comprising the storm detector

started, and the generating units themselves run at low speed.

These conditions prevail until that later time when the bell gives an insistent warning by uniting its periodic strokes into a continuous ringing. This will ordinarily occur at about one-half hour to one hour before the storm reaches the city. It has been found quite often that even at this time the sky will remain clear and unclouded to the eye, which shows how much superior are the services of a storm detector to those of a watchman stationed upon the roof to observe the conditions prevailing in the sky. (This latter practice was the best one available prior to the development of the storm detector.) The switch short-cir-

cuiting the detector is closed when the bell begins to ring continuously to protect the receiving apparatus, for the storm will now be comparatively close, and to silence the bell for its warnings are no longer needed, since it is positively known by this time that the coming of the storm is a certainty. Simultaneous with this action goes the order to synchronize the incoming generating units with the bus. Everything is now in readiness to supply the increased load which will be demanded in but a matter of minutes.

The following are actual records of the frequency of the bell warnings and the loads existing at various times preceding two storms last year.

July 28.

1:45 p. m., 1 bell.

2:15-3:30 p. m., 1 bell every  $\frac{1}{2}$  to 1 minute.

3:30 p. m., bell began ringing continuously, load 96,000 k. w.

4:15 p. m., (very dark, heavy rain storm), load 142,500 k. w.

August 1.

8:25 a. m.-2:00 p. m., 1 bell every 3 to 5 minutes.

2:02 p. m.-2:15 p. m., 1 bell every  $\frac{1}{2}$  minute, load at 2:00 p. m., 100,000 k. w. (cloudy).

2:15 p. m.-3:20 p. m., bell ringing continuously.

## AEROPLANE SETS ON VIEW

At the First Pan American Aeronautic Exposition, held in Grand Central Palace, New York City, February 8 to 15, serious consideration was given to radio equipments for aeroplanes and balloons. A large space was set aside for the exhibition of different types of sets, such as are used now in the European countries for directing the artillery from aeroplanes, for interfering with stations and for long distance communication by observers. There were also models of the different types of wireless equipments using direct and alternating current generated by small dynamos which get their power from the air by means of a small propeller. The Marconi Company was invited to exhibit the set which was recently purchased by the

3:45 p. m., load 150,000 k. w.

The storm detector as described is in service and located in the office of the system operator in the Waterside stations of the New York Edison Company. These stations so far as it is known are the only one possessing a device of the same nature.

The field for such a device among steam-driven lighting stations would seem to be in the larger cities, particularly in those which possess crowded office districts as it is the load derived from such a source that is most sensitive to changes in daylight.

A field in which it would also seem that the device would furnish valuable service is that of keeping the isolated hydro-electric station informed as to the weather conditions existing in the distant cities which it is supplying with lighting current. The places of generation and consumption being so far separated, a visual observance of the weather conditions at the power plant would be of no use. By means of storm detectors located in a few of the widely separated towns, which receive lighting current from the station, the attendants may keep forewarned by a bell in their station as to the irregular demands which may be made on them by storm clouds passing over those distant towns.

Navy Department for hydroaeroplanes. This instrument has 1 k.w. capacity and it is stated that ranges up to 300 miles will be obtained. The total installation weighs within 100 pounds. Other sets were made by the Sperry Gyroscope Company, DeForest Radio Telephone & Telegraph Company, William Dubilier, Wireless Specialty Apparatus Company, Cutting & Washington, Manhattan Electric Supply Company and A. B. Cole. Operators were supplied by the East Side Y. M. C. A.

The government of India, it has been announced, will extend its wireless system until every army post has a station in charge of a trained officer.

# General Advice For The Amateur Experimenter

By Elmer E. Bucher

THE article for this series published in the January issue, contained information regarding several important problems met with by the amateur wireless operator, and it may be helpful to continue the discussion, pointing out additional means and methods whereby such vexed questions can be solved.

Beginning with the transmitting aerial, let it be understood that it should never be erected parallel to power, telephone or telegraph wiring. Because of the voltage of current flowing in the transmitting aerial and the corresponding magnetic and static fields set up thereby, rather high voltages may be induced in these wires with consequent injury to the apparatus to which they are connected.

The rule to follow is to erect the aerial as far as possible from all exposed wires and always let the antenna bear a right angle to them. The inductive effects will then be at a minimum, although telephone circuits may still be interfered with. One experimenter, an acquaintance of the writer, had a transmitting aerial parallel to his house telephone wires which not only picked up enough current to interfere with conversations over the telephone, but also interfered with several telephones in the neighborhood as well. The interference of the transmitting set was almost completely eliminated by employing a lead covered twin copper conductor to connect the house phone to the junction box, the lead sheathing being connected to earth.

A means of permanently eliminating induction troubles of this kind is to place all wiring within 300 feet of the transmitting aerial in metallic conduit under earth. This is a sure, although expensive, method. Being well aware that in many instances, this action would not be permitted, even if possible, we can offer but little comfort to the experimenter who must now content himself with receiving experiments alone.

Speaking of the aerial insulation, it is important that the insulators at the far end of the flat top portion of the antenna have considerable length as well as a high degree of specific insulation. Porcelain has not proven satisfactory as an insulator at this point, because of its tendency to absorb and hold water. Glass or hard rubber insulators seem to maintain their insulating qualities over a greater period than other materials and they are therefore favored. It should be remembered that hard rubber rods, 2 feet in length, are used by commercial wireless telegraph companies for insulation of the aerial wires, and the amateur would do well to follow suit. For amateurs' use these rods should be at least 1 foot in length, 1 inch in diameter. One should be attached to each wire and then to the spreader.

There is frequently some argument concerning the spacing of the wires of an aerial. Generally there is no advantage in exceeding a space of 3 feet between wires and therefore, a four-wire aerial requires a spreader about 9 feet in length. This spreader is preferably made of spruce or bamboo. If made of spruce it should be 2 inches in diameter at the center, tapering to  $1\frac{1}{2}$  inches at the ends. Very wide spacing of the wires is only of advantage where the flat top portion of the antenna is exceedingly limited in length.

Regarding the insulator carrying the lead-in wires to the instruments: A hard rubber tube protected from dampness by a cone-shaped metal water drip fulfills all requirements. The lead-in wire may be brought out to the center of the tube and made water-tight by filling the space between it and the walls with melted sulphur. When this sulphur hardens it will make the hard rubber tubes water-tight.

Communications are often received from amateurs regarding the performance of this or that make of high volt-

age transformer supplied to the amateur market. Some of these questions refer to the overall efficiency, the probability of burn-out and whether or not the lights will flicker when the transmitting key is closed. Although we endeavor in the interest of our readers to obtain general information concerning the different types of transformers, we have not always been able to obtain detailed replies. The logical course to take in cases of this kind, is to apply directly to the manufacturer for the desired information. If it is withheld a full report should be made to THE WIRELESS AGE and an attempt will be made to obtain it.

Cases in which a 60-cycle transformer was sold to the amateur when the current supply in his locality happened to be 125 cycles, have been frequently brought to our attention. This, of course, resulted in a decrease of efficiency in the transformer and did not give the desired output. The manufacturer is not to be blamed for this error because it is up to the purchaser to first ascertain the frequency of the local current before placing his order. In fact he would do well to study the fundamental principles of amateur wireless telegraphy before purchasing a single instrument, thereby saving himself no small amount of trouble when it comes to the insulation of the apparatus.

## Advantage of the Open Core Transformer

The advertising columns of electrical magazines indicate that the general trend of the amateur manufacturers is in the direction of the closed core transformer, but the uninformed experimenter hears a series of arguments from other sources in favor of the open core type and is often at a loss to decide which type to purchase. That this is a much disputed question among the experimenters we have ample proof, and therefore it may interest some to learn our opinion regarding the subject. Properly designed, the two types of transformers are equally efficient, but the closed core type requires less material and is cheaper to build; herein lies the secret of its popularity among the manufacturers. The closed core type, however, is *not* the

least difficult for the amateur to construct, as many of our readers have found by experience. Ask any experimenter whether he prefers to cut out a number of iron laminations for the closed core type or whether he does not consider it much easier to construct a straight iron core of a bundle of fine iron wires. He will undoubtedly reply that he not only finds the core of the open core transformer less difficult to construct, but that it is also much easier to place the windings of the transformer in position.

## The Ideal Set

Due to the fact that the condenser in the closed oscillation circuit of a wireless telegraph set is limited to .01 microfarad, maximum, and that a more practical value is approximately .008 microfarad, we are in a dilemma when designing a transformer for the maximum power rating for use with a 200-meter set. To consume more than  $\frac{1}{2}$  k. w. at a frequency of 60 cycles, it is necessary to employ secondary voltages in the region lying between 18,000 and 20,000 volts. The objections to high voltages at the secondary are: (1) the strain on the condenser, (2) the strain on the insulation of all radio frequency circuits, (3) the increased strain on the condenser plate, (4) the necessity for a larger condenser. In addition to the foregoing objections in case a simple plain spark discharger is employed, a spark gap of excessive length is required to keep the spark free from the arc. This introduces excessive damping in the closed oscillation circuit and lowers the efficiency. The last two disadvantages may be done away with by the use of a non-synchronous rotary spark gap which not only helps to eliminate the arc of the transformer, but at the same time permits the use of a short discharge gap. Summing up the foregoing, the reader should have no difficulty in determining what in our opinion constitutes the ideal 200-meter transmitting set. It is one consisting of a  $\frac{1}{2}$ -k.w. 18,000 to 20,000-volt transformer, a high potential condenser arranged for series parallel connections, a non-synchronous rotary spark gap designed to give about 300

breaks or spark discharges per second, and an inductively-coupled oscillation transformer.

**High Potential Transformers**

The principal trouble with high potential transformers seems to have to do with the flickering of lights and the failure of the transformer to give a clear spark discharge with capacity of less than .01 microfarad. It is in order for the manufacturers to design a 60-cycle transformer for a capacity of .008 microfarad that will not cause the lights to flicker throughout the entire neighborhood when the transmitting key is closed. In fact they should design a constant current transformer, one whose primary self inductance remains practically constant under the conditions imposed by the discharge of the condenser across the spark gap. Incidentally, the transformer should function independently of an external reactance and the latter should only be supplied in case a variation of the power is required.

We now come to the problem of inside wiring. In the majority of cities the installation of power apparatus is governed by the local electrical code which generally requires that the wires be placed in metallic conduit. This precaution not only introduces a factor of safety but also protects the power circuit, the meters, the house wiring fixtures, etc., from electro-static induction set up by the wireless transmitter. Power switches that are apt to arc when the circuit is broken should be enclosed in metallic boxes. Low potential wires should always be placed at right angles to and at a distance from all high voltage circuits. Dangerous parts of the radio frequency circuits should have markers to protect those ignorant of the laws of electrical current from accidental contact.

A considerable number of readers inquire from time to time concerning the size of the wire for connecting up the transmitting and receiving circuits. Data for the wiring of the high potential transformer can be obtained from the local inspector's office in any city. The circuit from the secondary winding of the high voltage transformer to the

condenser need have wire no larger than No. 18 bell. The primary circuits of the transformer should be wired up with No. 10, No. 12 or No. 14 single braid rubber-covered wire. The receiving apparatus can be connected up with annunciator wire or rubber-covered No. 18 B. & S. wire.

The circuits of radio frequency should be connected with No. 4 or No. 6 stranded wire while the oscillation transformer should be made of either copper tubing, stranded wire or copper strip. The earth lead for transmitting sets should be one of considerable current-carrying capacity. The underwriters, as a rule, require an earth lead from the lightning switch of No. 4 copper wire, thoroughly insulated from the building. If it is connected to water pipes it must be attached to the street side of the water meter. If No. 4 stranded wire is not available for this purpose, the amateur should wind up a cable of a dozen or more smaller wires, making sure to have them practically of identical length. also the lead-in wires from the flat top portion of the aerial to the apparatus in the station should have conductivity equal to the wires of the flat top portion.

Power wires inside the station carrying alternating current should never lie parallel to any part of the receiver circuit wiring. Otherwise a humming noise may be set up, seriously interfering with the reception of weak signals. Care should be taken to see that the receiver wiring is not placed close to any part of the closed oscillatory circuit as disastrous potentials may be induced therein. It may be said finally in connection with wiring up of a station that simplicity is the keynote of success and that every possible effort should be made to simplify all circuits and connections throughout the entire installation.

**Range Determination**

There is no better way to determine the range of a wireless station, mathematical formulæ notwithstanding, than by actual experiment. It is a foregone conclusion that an owner of an amateur set has some knowledge of the telegraph code and therefore to determine his receiving range he can do no better than

to listen to stations actually transmitting, noting their call letters at the termination of a sending schedule. By referring to the Government call list, the name of the particular ship or shore station is at once obtained; reference to a map permits an approximate measurement of the distance between the two stations and the range is at once determined. The position of vessels can be obtained from the ship's position report, which in some instance is sent twice daily, and this will permit the receiving operator to measure on the map the distance intervening between the ship and his station.

In the same manner the range of the transmitting station is obtained. By ref-

erence to the Government call list and the list of additional amateur calls published each month in the Monthly Service Bulletin of the National Wireless Association, nearby stations can be located and a schedule for making tests arranged by letter. These tests can be gradually extended to include greater distances until the maximum possible range is obtained.

In connection with these experiments it should not be forgotten that the range of a 200-meter station is considerably greater after dark than during the daylight hours; therefore to attempt to carry out such tests in the daytime, would be useless.

*(To be continued)*

**License for Carranza's Operator**

To a slip of a girl from Mexico—Maria Dolores Estrada—belongs the distinction of winning a commercial wireless operator's license of the first grade. At the age when many girls in this country are just leaving home for boarding schools, Maria was watching men kill each other in frenzy of battle. She has known what it is to languish, starving and without water, in one of those horrible Mexican prisons; and she has hidden, terror-stricken and alone, while the terrible Villa and his more terrible bandit followers, have searched from house to house to find her.

For two years before she came to Washington she served on the official staff of General Venustiano Carranza, first chief of the de facto government of Mexico and leader of the rebellion against Huerta. When she arrived in

Washington, about a year ago, she could not speak a word of English. Her father having died when she was only twelve years of age, she had learned telegraphy and at fifteen was a government telegrapher in Zacatecas.

Eventually she came to the attention of Carranza, who employed her at once as his private telegrapher on his official staff. Then the first chief decided that she should come to the United States to learn English, and she entered the Fairmount Seminary as official ward of the Mexican government.

But Maria wanted more than a knowledge of English. She heard that by using her spare time she could add to her knowledge of telegraphy a knowledge of wireless telegraphy.

How she applied herself is mutely testified to by the certificate which was issued to her on October 21.

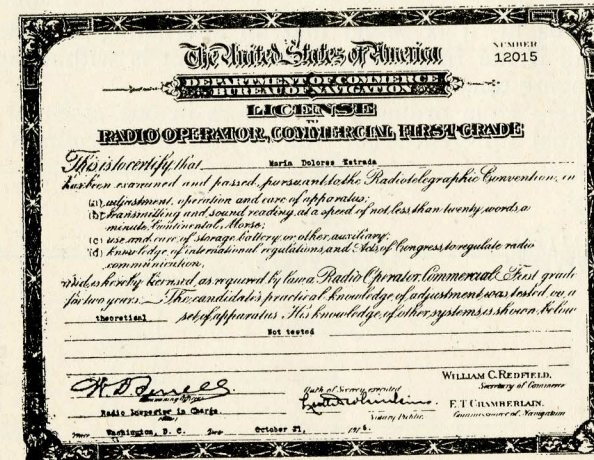

# Radio Telephony

By ALFRED N. GOLDSMITH, PH.D.

Director of the Radio Telegraphic and Telephonic Laboratory of the College of the City of New York

## ARTICLE III

(Copyright, 1917, by Wireless Press, Inc.)

It will be seen from the previous treatment of the subject of radio telephony that a complete one-way installation comprises a generator of practically sustained waves at the transmitting station, a means for controlling or modulating the output thereof, an antenna and ground system for radiating a portion of the modulated energy; and, at the receiving station, an antenna and ground system, and a radio receiver with or without suitable amplifying devices.

It is proposed to consider first the various types of sustained wave generators which may be used in radio telephony.

**6. SUSTAINED WAVE GENERATORS. (a) ARCS.** For the sake of completeness, we shall give here a description of the theory of the arc and its historical development from one of our earlier papers:

"The simplest generator of radio frequency oscillations of considerable power is the Duddell-Poulsen arc. In Figure 12 is shown the arrangement used by Duddell.  $G$  is a direct current generator,  $R'$  is a resistance intended to control the arc current, and  $L'$  a choke coil intended to keep the alternating current out of the generator and also to steady the supply voltage.  $K$  (for the Duddell arc) has solid carbon electrodes.  $L$ ,  $C$ , and  $R$  are inductance, capacity, and resistance inserted in the arc shunt circuit. Their values should be carefully chosen.

"If the arc be lit, it is found that an alternating current appears in the shunt circuit, and if the frequency of this current is within the limits of audibility, a pure singing tone will be heard."

The arc differs from ordinary conductors in one essential respect. If we divide the potential difference (or voltage) at the terminals of an ordinary

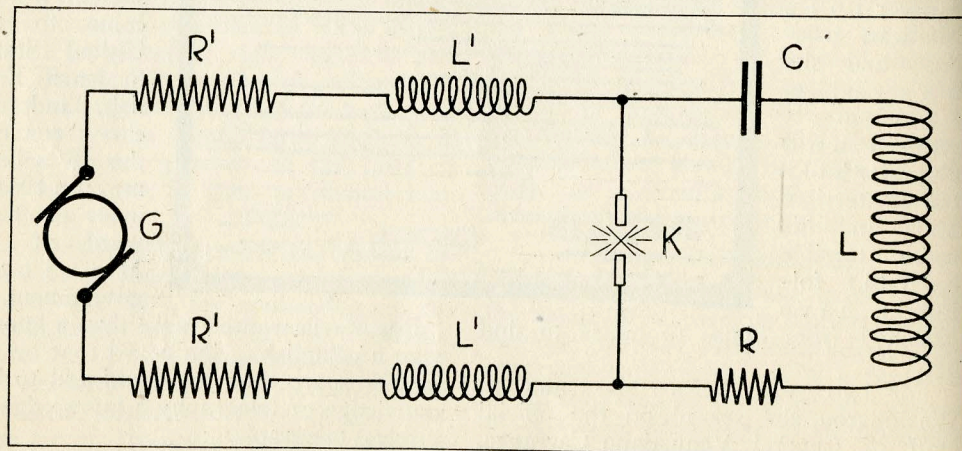

Figure 12—Typical arc circuit

metallic conductor by the current flowing through the conductor, the quotient is found to be a constant quantity called the resistance of the conductor. This is the case regardless of the values of voltage and current (at least, until the conductor becomes heated by the passage of excessive current). In the arc, the quotient of voltage divided by current is by no means constant. In fact, for high voltages the arc resistance is a large quantity and very little current passes through the arc under such voltages. For moderate voltages, the arc resistance is much less, and moderate currents pass. For low voltages, the arc resistance becomes exceedingly small and the arc current tends to increase indefinitely; that is, the arc is unstable and tends to become a short-circuit. We are forced then to the conclusion, that a small increase in the voltage at the terminals of an arc causes a small decrease in the resultant current; and consequently we sometimes speak of the "negative resistance" of an arc as distinguished from the ordinary or positive and current-limiting resistance of metallic conductors.

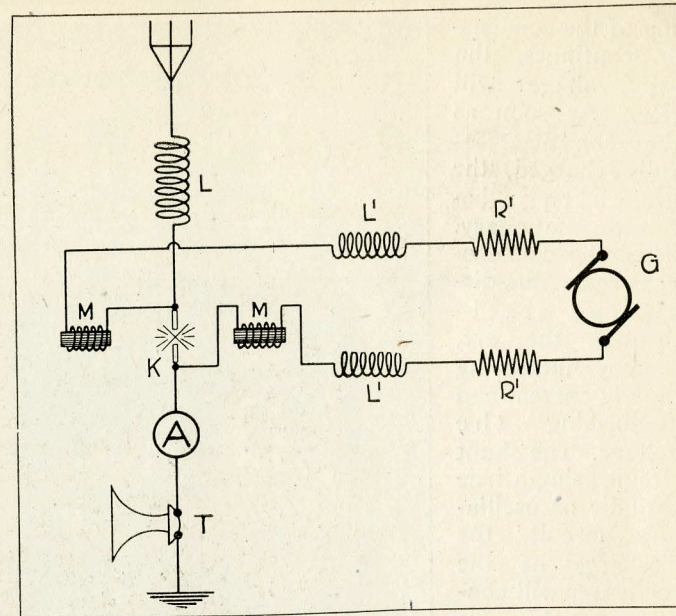

Figure 13—Typical arc radiophone transmitter

"The theory of the action of the singing arc is the following: When the

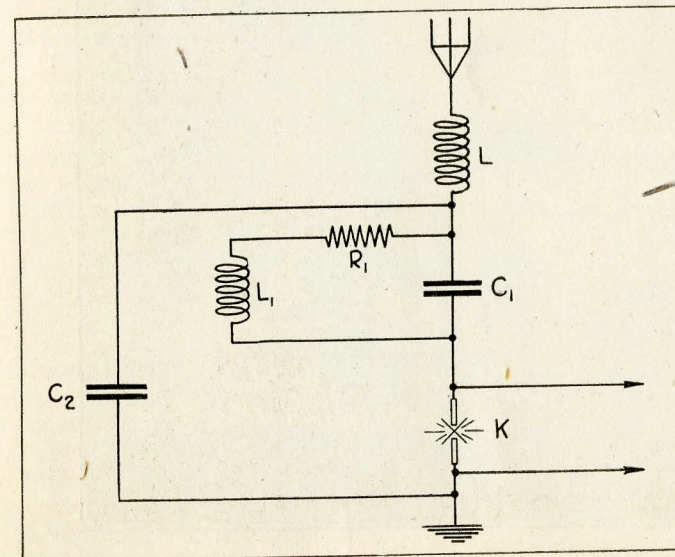

Figure 14—Fuller's method of increasing arc efficiency

condenser and the inductance in the shunt circuit are connected to the arc, the condenser begins to accumulate a charge, and therefore robs the arc of a part of its current, since the supply current is kept appreciably constant by the presence in the supply leads of the choke coils  $L'$ . If the current through the arc decreases, it is clear from the foregoing considerations that the voltage at its terminals must increase. Consequently, as long as the charg-



ing of the condenser continues, the arc voltage will rise. As soon as the condenser is fully charged, the arc voltage becomes stationary. Then the condenser begins to discharge itself through the arc, thereby increasing the arc current and diminishing the voltage. The shunt circuit being a true periodic or oscillatory circuit, the discharge of the condenser will continue past the point of zero current, and there will occur an actual reversal of current.

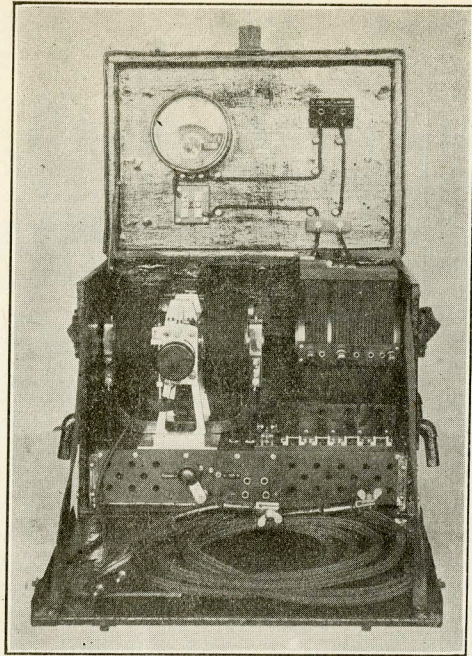

Figure 15—Berliner-Poulsen arc for portable stations

Thus the condenser becomes charged in the negative direction until the arc voltage falls so far that the supply voltage of the direct current generator causes a reversal of the whole action. The cycle is then repeated, and with a frequency related to a certain extent to that of the natural oscillations of the shunt circuit. The mode of vibration which takes place in the arc is thus closely analogous to the action in an organ pipe of the reed type.

In 1903, Poulsen

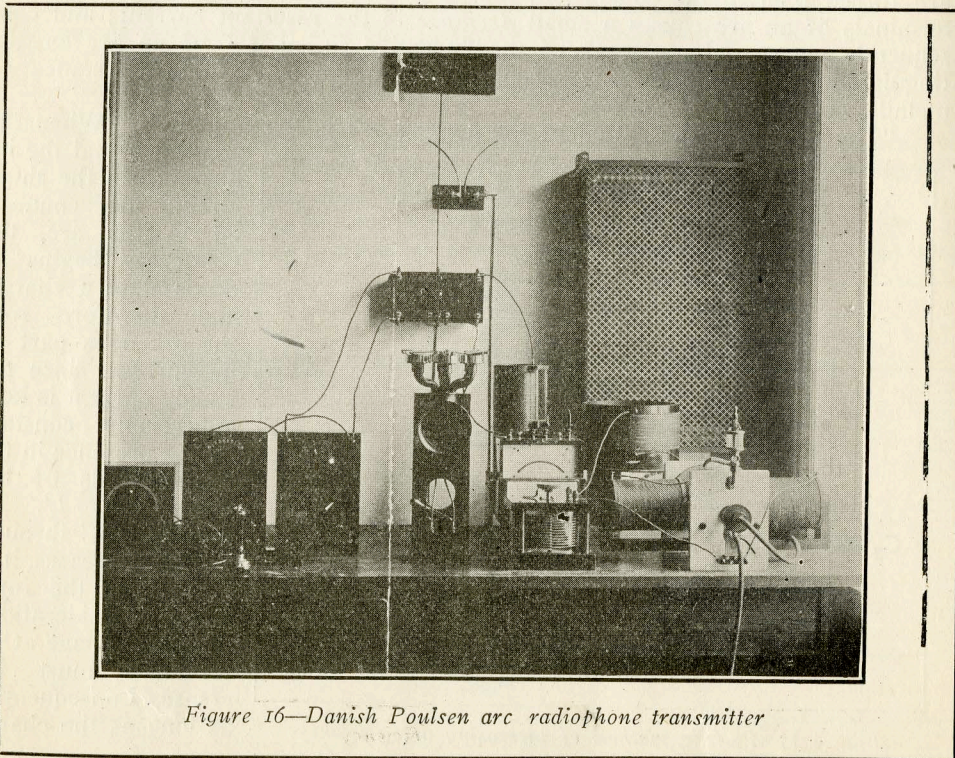

Figure 16—Danish Poulsen arc radiophone transmitter

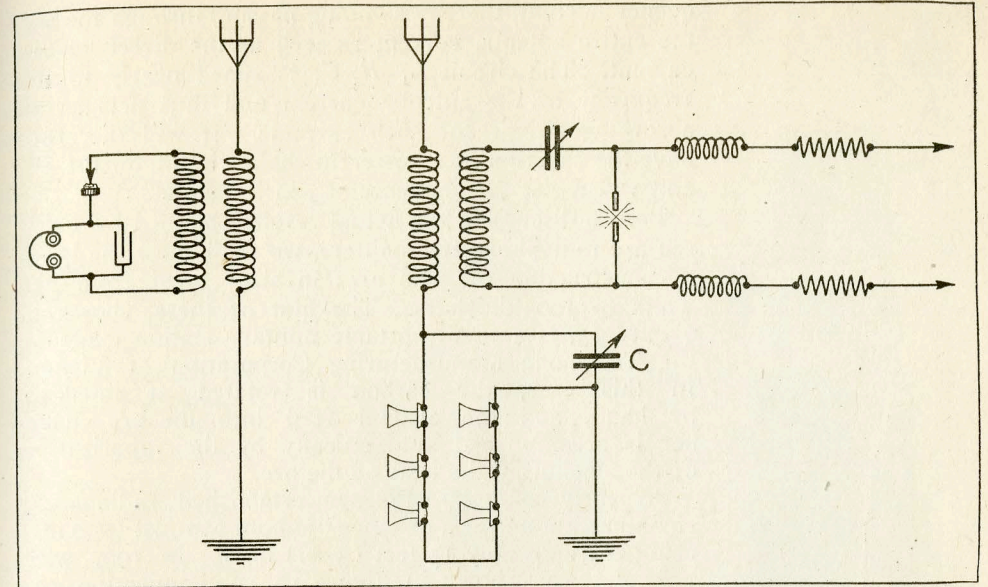

Figure 17—Poulsen radiophone transmitter and receiver

raised the arc to the status of a practically operative generator of radio frequency energy in considerable quantity by the following changes: placing the entire arc in an atmosphere of hydrogen or a hydrocarbon vapor (e. g., alcohol or gasoline), using a carbon electrode for the negative side and a copper anode water-cooled for the positive side, rotating the carbon electrode slowly by motor drive, and placing an intense deflecting magnetic field transverse to the arc. Except for certain constructional and electrical details, this is the Poulsen arc of today.

In Figure 13 is shown a typical arc radiophone station. The arc  $K$  is shown with the magnetic field due to the coils  $M$ .  $A$  is an ammeter for measuring the antenna current, and  $T$  is a heavy-current transmitter, usually of the carbon microphone type. The control methods which may be used with arcs other than that shown will be considered under another heading. A modern improvement in arc transmitters, and one which results in a great increase in over-all efficiency of the arc, is that shown in Figure 14. This is due to Mr. L. F. Fuller, and the inventor states that very marked increases in output result when it is used. It consists first: in placing in shunt with the arc and the antenna series condenser  $C_1$  the condenser  $C_2$ , and second: in placing around the series condenser  $C_1$  an inductance  $L_1$  and a resistance  $R_1$ . The chief function of the condenser  $C_2$  is to act as a by-pass for the radio fre-

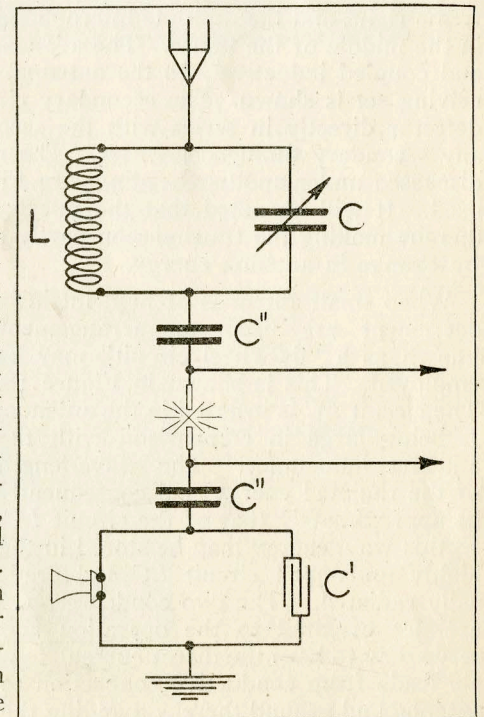

Figure 18—Flywheel Poulsen arc circuit for radio telephony

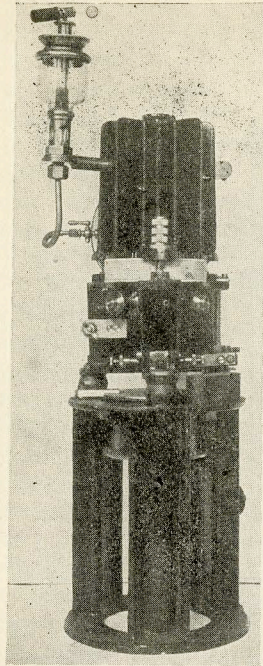

Figure 19—Lorenz-Poulsen arc for radio telephony

quency current, thereby avoiding passing through the arc the entire antenna current as well as the direct supply current. The circuit  $L_1 R_1 C_1$  is tuned nearly to the frequency of the antenna current and thus acts as an absorbing circuit for such currents. It will therefore have the function of a powerful choke circuit for the arc and will assist the condenser  $C_2$  in its action.

Before discussing the actual results obtained by Poulsen arc radiophone transmitters, we shall show the types of construction of such arcs in sizes rated from 250 watts to 100 kilowatts. The first of these, shown in Figure 15, is a small portable military station made by the Telephone Manufacturing Corporation of Vienna. In this case, the carbon is rotated at intervals by hand, and the alcohol feed into the arc chamber is accomplished automatically by the vaporization of the alcohol by the heat of the arc.

As early as 1906, Poulsen established radiophonic communication over a distance of about 600 feet (200 m.) using antennas only 15 feet (5 m.) high. In 1907, with the equipment shown in Figure 16, communication was established between Esbjerg and Lyngby, a distance of 170 miles (270 km.). The antenna height was 200 feet (60 m.), the wave-length 1,200 meters, the arc supply power 900 watts, and the antenna power 300 watts. Later, phonograph music was heard in Berlin after transmission from Lyngby, a distance of about 300 miles (500 km.). In Figure 16, the arc is shown to the extreme

right, and the multiple microphone transmitter (six microphones in series) in the middle of the figure. The arc was in its own primary circuit in this case, and coupled inductively to the antenna. At the left, the inductively coupled receiving set is shown. The secondary circuit was made aperiodic by placing the detector directly in series with the secondary coupling inductance and without any secondary tuning condenser. The reasons for this type of receiver will be discussed under another heading. In Figure 17 are illustrated the arrangements used. It will be noted that the microphones are shunted by the condenser  $C$ , thereby making the transmission partly one by change of wave-length as well as by change in antenna energy.

When small antennas of high intrinsic decrement are used, an arrangement known as a "fly-wheel circuit" may be employed. This is shown in Figure 18. The circuit  $LC$  is inserted in the antenna,  $L$  being large in comparison with the antenna inductance. The wave-length of the radiated energy will consequently be approximately that of the circuit  $LC$ . In this way, energy may be stored in the highly undamped circuit  $LC$  and gradually radiated. The two condensers  $C$  are not essential to the operation and serve only to keep the direct current supply leads from conductive connection to antenna and ground thereby avoiding the possibility of serious high voltage shocks when touching the antenna. In the case

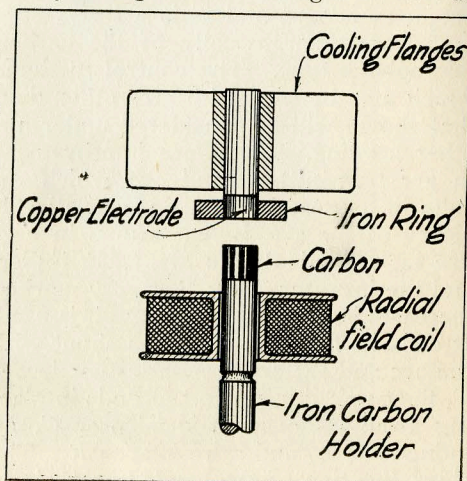

Figure 20—Construction of Lorenz-Poulsen arc for radio telephony

shown, the microphone-shunting condenser,  $C$  has a value between 0.05 and 0.20 microfarad.

In Figure 19 is given a photograph of an arc rated at about 100 watts output, and built by the C. Lorenz Company of Berlin specially for radio telephony. Its construction is shown in Figure 20. The carbon holder is of iron, and forms an open core of a circular multi-layer coil which produces a moderately strong magnetic field passing directly upward through the carbon. The field then spreads outward to the upper iron ring, passing radially through the arc in so doing. In consequence of the presence of this field, the

arc will slowly rotate around the edge of the carbon, thereby causing even wear. The copper electrode is held within the iron ring, and provided with massive cooling flanges. In Figure 19, the alcohol sight-feed cup is seen at the top, and the vertical cooling flanges below and to the right. The insulator between the upper and lower electrodes is a heavy ring with flat faces, made of plaster with asbestos facings. The clamping screws are also visible, as are the two poppet

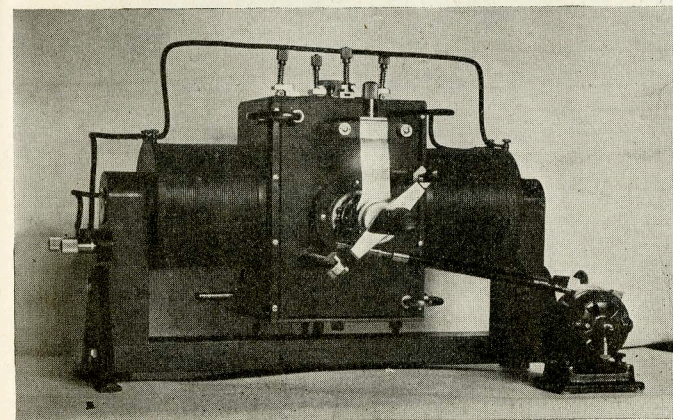

Figure 22a—Continental Syndicate Poulsen arc

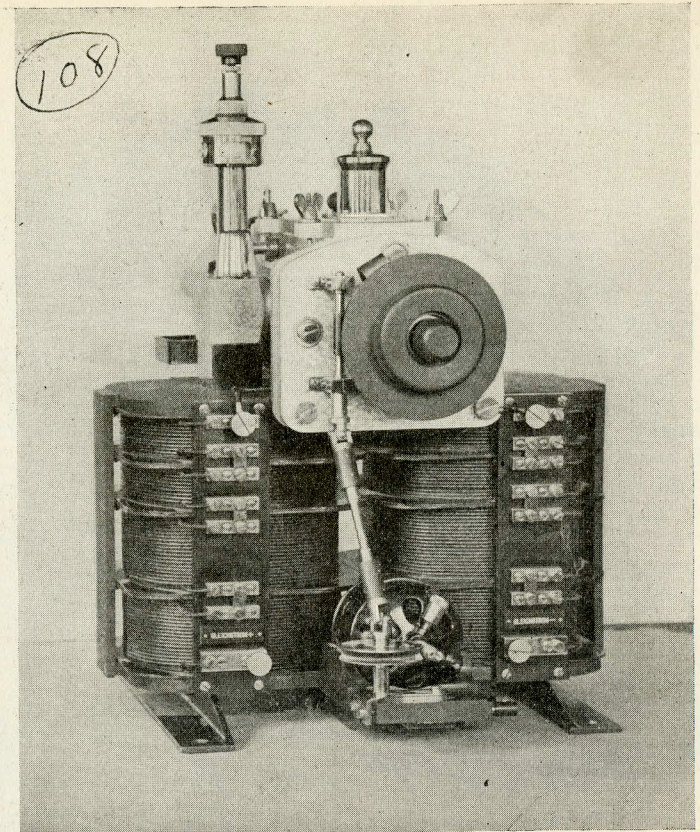

Figure 21—3 k.w. Berliner-Poulsen arc

safety valves which relieve the excessive pressure resulting when the arc is first lit and the mixture of alcohol vapor and air explodes. The lower electrode holder and the surrounding coil are just below the middle of the illustration.

One of the defects of these small arcs is the necessity for adjusting the arc length occasionally

as the carbon burns away. To overcome this, the Lorenz Company has built a self-regulating arc provided with a mechanism somewhat like the magnetic length-control of an ordinary street lighting arc. The device is supposed to be very effective in practice.

A somewhat larger type of arc of 3 K. W. input made by the Telephone Manufacturing Corporation (formerly J. Berliner), of Vienna, is illustrated in Figure 21. It will be noted that provisions are made here for an extremely intense magnetic transverse field. While this is of advantage in increasing the available radio frequency output, it tends to cause a certain degree of irregularity in the output with a resultant crackling noise or "side tone" in the received speech. This last defect may prove extremely serious, so that magnetic fields on arcs used for radio telephony must be employed with caution, and with associated circuits and outputs which minimize arc unsteadiness. In Figure 21, the small motor which rotates the carbon electrode is seen in the lower central portion, and there are also shown the sections of the magnetic field whereby the field strength may be conveniently varied. The heavy insulation surrounding the push button

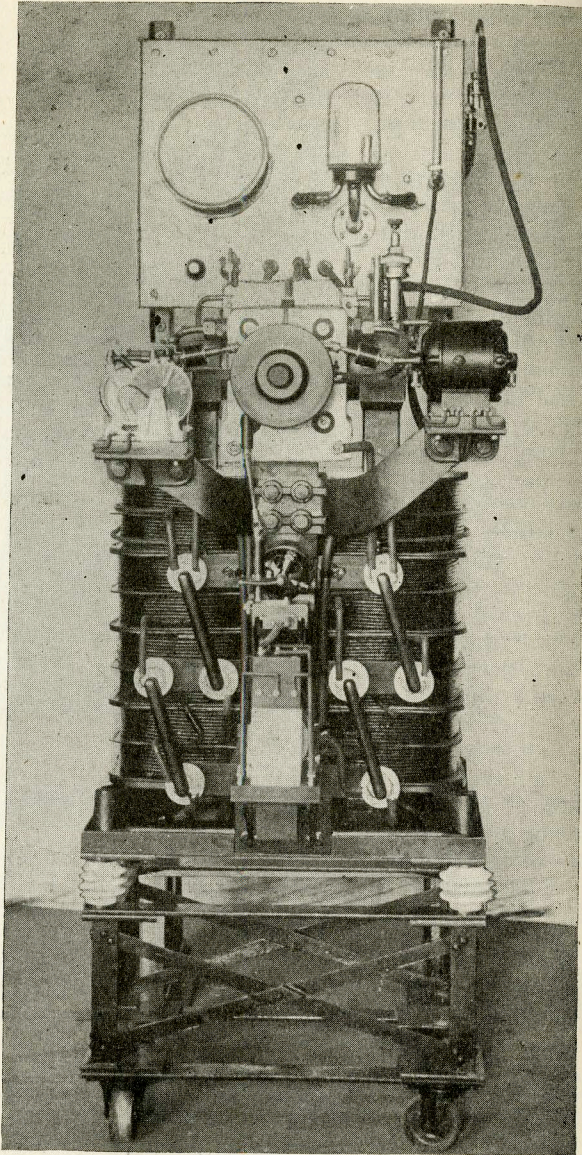

Figure 22b—Berliner 25 k.w. Poulsen arc

used for striking the arc at the beginning of operation is a necessary adjunct since disagreeable burns are easily sustained when using high power arcs carelessly. An arc of somewhat smaller output than that shown is guaranteed by the makers for telegraphy over 125 miles (200 km.) when using portable masts, but for only about 12 or 15 miles (25 km.) for radio telephony.

A somewhat larger type of arc, built by the Danish Poulsen Company (Det Kontinental Syndikat), is shown in front view in Figure 22a. The massive field magnet coils, the driving motor for the carbon holder, and the arc striking and adjusting knobs are visible. It is to be noted that all arcs giving any considerable output have air core choke coils in the feed circuit, since the distributed capacity of iron core coils gives rise to the possibility of injurious resonance phenomena inside the coils and permits radio frequency currents to pass.

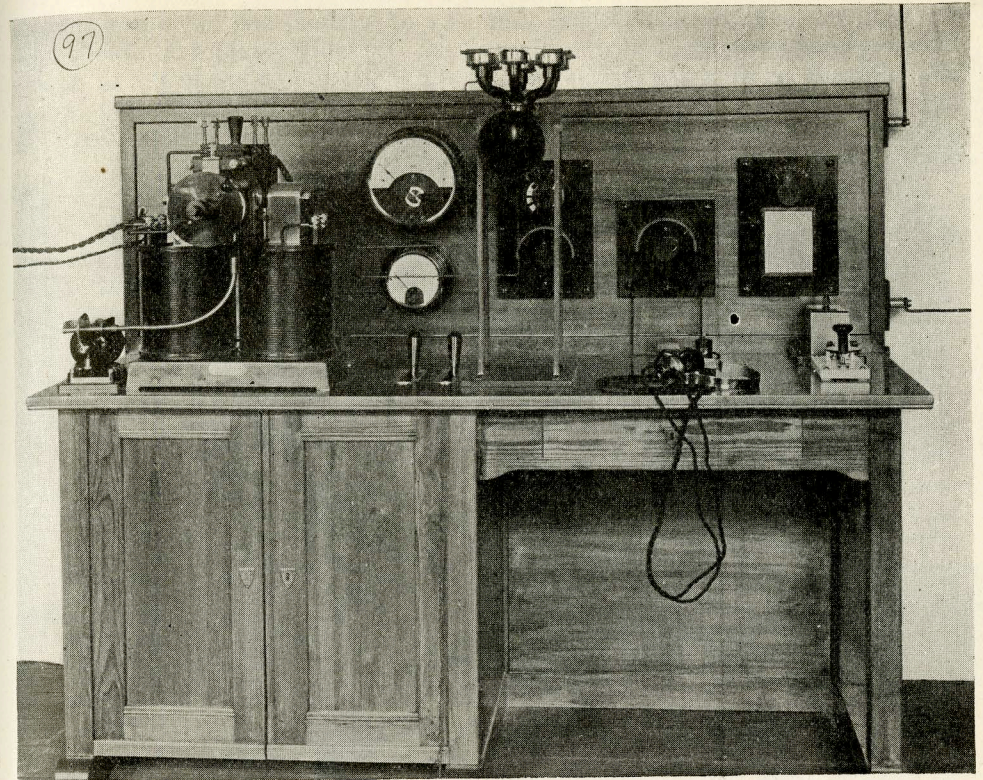

Figure 23—Berliner-Poulsen arc ship radiophone station

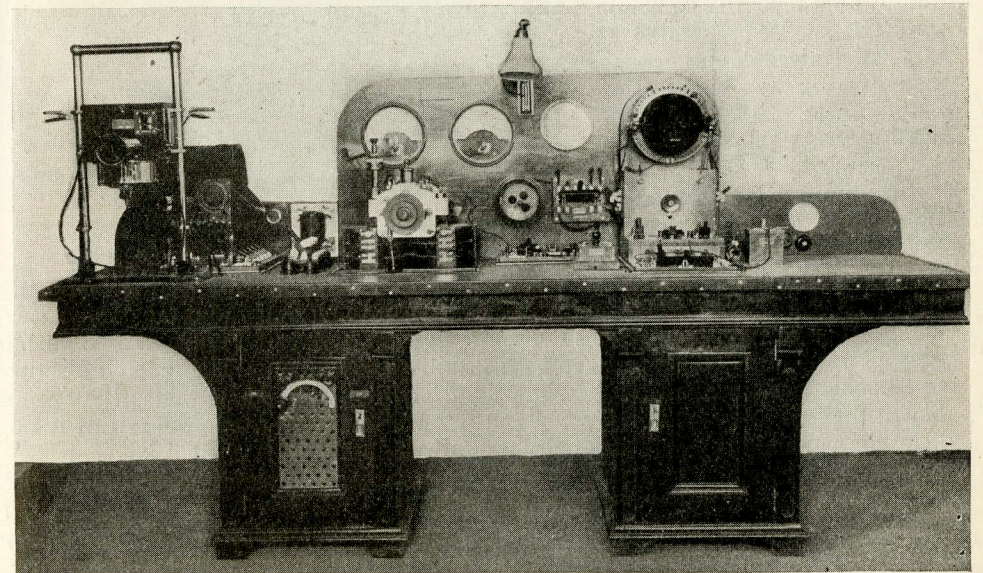

Figure 24—Berliner-Poulsen 3 k.w. arc radiophone station

An arc made by the Berliner Company of Vienna, and having an input of 10 to 25 kilowatts is illustrated in Figure 22b. As will be seen, it is provided with an automatic ignition device, a device for the indication of arc length or wear of the carbon electrode, a mixing chamber of glass for the gas used in the arc, and a complete water cooling system for the field magnet coils as well as for the arc.

Some interesting information relative to Poulsen arc radiophones of the type shown in Figure 23 is given by Captain Anderle. Figure 23 is a ship station of a complete type, being used for either telegraphy or telephony. The arc, which is normally rated at about 8 kilowatts input, is shown at the left. For telephony, it is used at reduced power, inasmuch as the multiple microphone transmitter at the right would be incapable of modulating the full output. About 3.5 amperes (and never over 4) are passed through the transmitters, which are placed directly in the ground lead of the antenna. With masts 150 feet (45 m.) high, distances of from 30 to 60 miles (50 to 100 km.), are covered over flat country. The speaker is warned to speak distinctly but not too loudly, with the mouth held near the transmitter. It is recommended to tap the microphones occasionally, or to have alternative sets so that overheating of one set does not occur.

In Figure 24 is shown an unusually complete set of the Poulsen arc type built by the Berliner Company of Vienna. This set is adapted at the same time to ordinary arc telegraphy, multi-tone arc telegraphy, and radio telephony. The arc is of 3 K. W. input, being the same as that given in Figure 21. The telegraphic range of this set is given as 375 miles (600 km.). The receiving set and test buzzer are mounted on the right-hand portion of the long table; the arc and key at the left center; the relay key and transfer switches are to the left of the arc near the variable transmitting coupling and the multi-tone control keyboard. In the extreme left foreground is the large microphone transmitter, to be described hereafter when control systems are considered.

Although the newer, high power arcs are not yet employed for radio telephony because of the great difficulty of modulating the output, nevertheless they form a possible direction of radio telephonic development. Accordingly, we show in Figure 25a an arc of 60 K. W. input made by the Federal Telegraph Company,

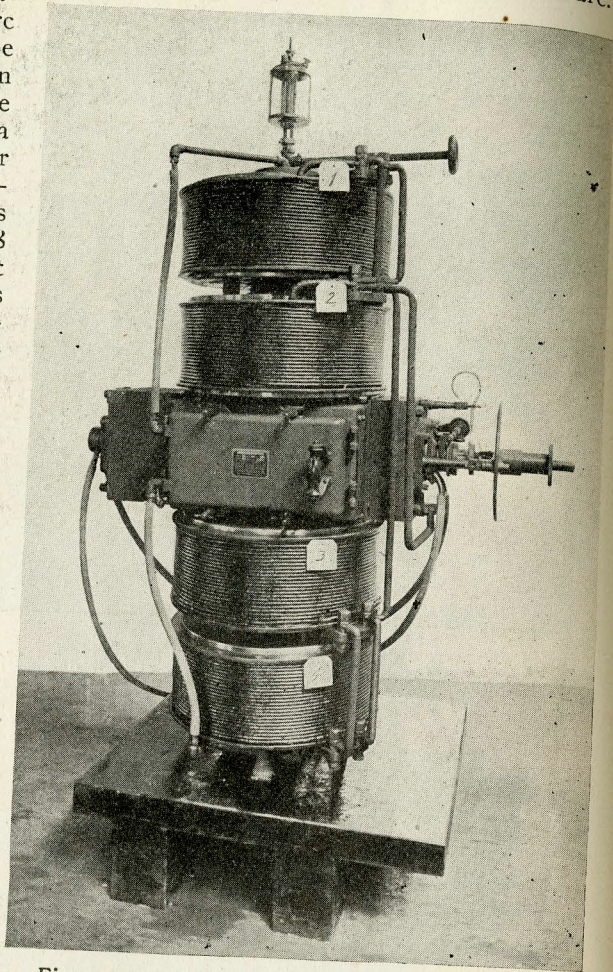

Figure 25a—Federal Telegraph Company 60 k.w. Poulsen arc at Tuckerton

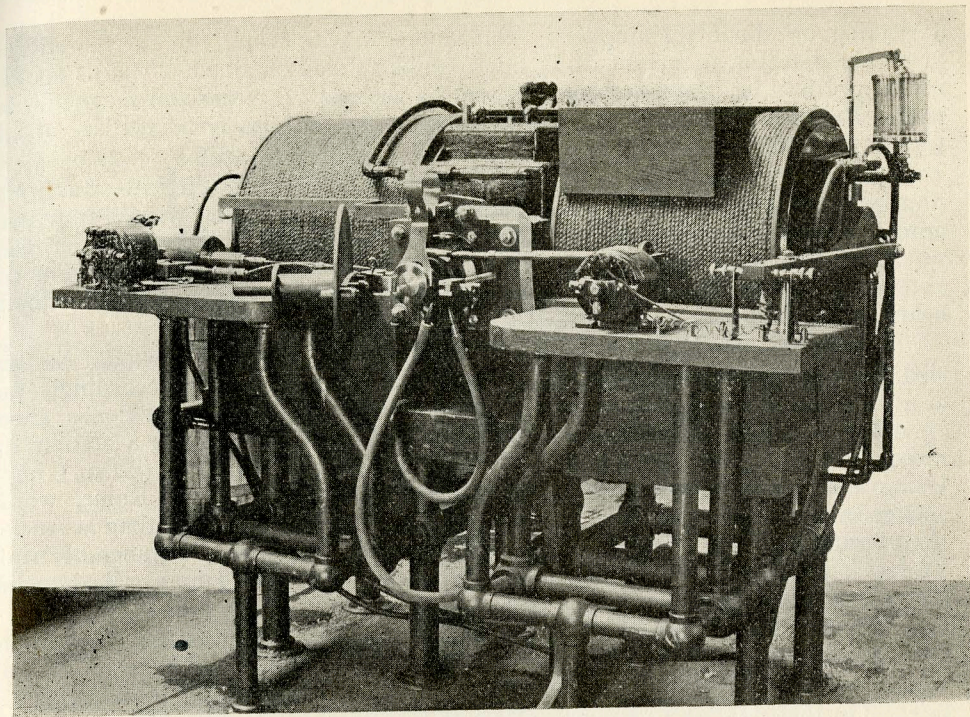

Figure 25b—Federal Telegraph Company 100 k.w. Poulsen arc at Darien

this corresponding to 500 volts and 120 amperes. It is this arc which is carrying a portion of the trans-Atlantic traffic from Tuckerton, New Jersey to Hanover Germany, a distance of 4,000 miles (6,500 km.). In this case, the antenna current is 120 amperes, the arc standing considerable overload. We also show, in Figure 25b, a 100 K. W. arc made by the same Company, and used for communication between the United States Naval Radio Station at Darien, Panama Canal Zone and Washington, a distance of 1,900 miles (3,000 km.). It will be seen that both these arcs are very sturdily designed and provided with an unusually rugged and elaborate water-cooling system.

The Federal Telegraph Company carried on radiophone experiments from 1910 through 1912 between the stations at San Francisco, Stockton, Sacramento, and Los Angeles (all in California). The distance between the two of the first three stations mentioned is 90 miles (140 km.) and between the first and the last station mentioned 355 miles (570 km.). Speech between San Francisco, Stockton, and Sacramento was clear at all times, but between these points and Los Angeles it was weak and indistinct. The antenna heights were 300 feet (94 m.)

Before leaving the subject of the Poulsen arc, it is of interest to give detailed accounts of just what has been accomplished by these methods in addition to the achievements already mentioned.

A remarkable series of experiments were made by Q. Majorana in 1908. The results obtained are best described in the words of Majorana himself:

"The first research was conducted in the Instituto Superiore del Telegraphia in Rome. The antenna was 78 feet (24 m.) high and had four wires. For two years, I have been conducting experiments between this station and a government naval station at Monte Mario, 3 miles (5 km.) away. The antenna at the latter station had also four wires and was about 175 feet (50 m.) high. An ammeter in the antenna at the former station showed under normal conditions of working

a reading of about 1.2 amperes. At Monte Mario, using the thermo-electric (crystal) detector, a current of 15 micro-amperes was obtained. Words spoken in Rome could be heard at Monte Mario by the use of a Marconi magnetic detector, but could be heard very much more loudly and clearly by the use of the former detector.

"Because of these results, the Naval Bureau provided a second research station at Porto d'Anzio, 25 miles (56 km.) from Monte Mario, with a four-wire antenna 145 feet (45 m.) high. On the 13th of August, 1908, the experiment was tried, and this showed that with a current strength of 3.5 amperes in the antenna at Monte Mario any words spoken in Rome could be very distinctly heard at Anzio.

"Hereupon the Naval Bureau ordered that these researches should be carried on over longer ranges. The torpedo boat 'Lanciere' was accordingly put at my disposal, and arrived on the 13th of November at the Island of Ponza, about 75 miles (120 km.) from Monte Mario. On this island there is a station for radio telegraphy, with an antenna of four wires about 200 feet (60 m.) high. Using the same receiving apparatus as had been employed at Rome, words spoken in Rome could be heard at Ponza with greater loudness even than at Anzio; the vibrations of the telephone diaphragm could be heard at a distance of 10 or 15 feet (3 or 4 m.). The superiority of these results is to be ascribed to the better location of the station at Ponza.

"On the 14th of November, the 'Lanciere' landed at Maddalena in Sardinia. The nearby station at Becco di Vela, which is similar to that at Ponza, was then used. The station is about 170 miles (270 km.) from Rome in an air line. On that day, at 12 o'clock, attempts to communicate with Rome were repeated and again gave excellent results. The voice at Monte Mario was distinctly audible, and the strength of the speech was not less than it is in the ordinary wire telephone in use in the city. We can, therefore, state that over this range a practically workable radio telephonic service can be provided.

"Finally, I desired to find the utmost range of the radio-telephonic apparatus at my disposal. On the 1st of December, the 'Lanciere' arrived at Trapani, in Sicily, where further attempts were made, using the radio-telegraphic station at Monte San Giuliano. This station resembles that at Ponza, and is 270 miles (420 km.) in an air line from Rome. It took quite some effort to secure sharp tuning here, partly because of considerable interference from a neighboring station, but finally the spoken word from Rome could be heard, even though it was faint and not easy to understand. The intensity in this case was barely sufficient for the trained ear to read. We were here at the limit of the range. This we proved more clearly on the following day. At Forte Spurio is a station which is about as far from Rome as that on San Giuliano, but less favorably situated. I went to Forte Spurio and found that the words sent from Rome could not be heard there.

"The utmost range of my system was by no means reached in these experiments, for the hydraulic microphone was not used to a point even approaching its full capacity." (Majorana used a Poulsen arc generator, but modulated the antenna energy by means of a special hydraulic transmitter which will be described under control systems.)

"I desire to mention one important point in these experiments. After several trials, it was positively shown that the quality of the word was not altered, even at distance of 250 miles (400 km.). That is, the articulation was clear and the fine inflections of the voice were preserved. This is because all the various frequencies contained in the speech suffer the same weakening for equal distances, so that there is no distortion of the speech. With the ordinary telephone lines, on the other hand, the propagation depends largely on the acoustic

period; in radio telephony, the period of the electro magnetic radio frequency oscillations is of the greatest importance."

Experiments were carried on at the end of June, 1909 between the large Poulsen stations in Denmark at Lyngby and Esbjerg, the distance between these stations being 170 miles (280 km.). The Egner-Holmstrom heavy current microphone, to be described later, was used directly in the transmitting antenna. Such microphones can carry 10 to 15 amperes, but it was shown that this current was unnecessary for the range in question. In fact, with an antenna current of 6 amperes properly modulated communication of a very good and clear sort ("sehr gut und deutlich" according to the experimenters) was established.

This is the third of a series of articles on "Radio Telephony" by Dr. Goldsmith, an eminent authority on the subject. In Article IV he continues his discussion of arc systems for radio telephony and also takes up radio frequent spark methods.

## DISTANCE DETERMINING APPARATUS

The following is furnished by the Bureau of Steam Engineering, United States Navy Department:

The attention of all ships navigating the approaches to New York Harbor is invited to the recent installation on Fire Island Light Vessel of a combined radio and submerged sound signal transmitter which determines the receiving ship's distance from the light vessel. (Call letters, NLS; station, lat. 40° 28' 33" N., lon. 73° 11' 24" W.)

This apparatus will be in operation during fog, mist, rain, or falling snow. The range of this apparatus is limited to the receiving range of the submarine bell receiving equipment employed on shipboard, and in all practical cases this is within six or seven miles.

The submarine bell strikes six strokes, pause, then eight strokes once every forty seconds. The clock mechanism on the light vessel operates so that about one-half second (the time taken for sound to travel one-half mile in sea water) after the first stroke of the six bell character is made, the ship emits a series of radio dots. These dots are spaced so that the interval between is that taken by sound to travel one-half mile in sea water. Since radio waves travel with the velocity of light, for moderate distances the time for transmission can be neglected. On a receiving ship, you hear the bell strike six, interval eight. About twelve seconds (time depending on distance from lightship) after the last stroke of the eight character, the radio dots start coming in.

In order to determine the distance of a ship from the light vessel it is necessary to count each of these radio dots until the *first stroke of the six submarine signals is received*. The number of dots thus determined gives the distance in half sea miles from the lightship.

*Example.*—(a) Eleven radio dots are received before the first stroke of the bell; the distance is eleven halves or five and one-half miles.

(b) Four radio dots are received; the first submarine bell signal appearing midway between the fourth and fifth radio signals; the total number of radio signals received is four and one-half, and the distance is four and one-half divided by two, or two and one-quarter miles.

The most convenient method of receiving these signals is to have one receiver connected to radio and the other receiver connected to submarine bell detector, thereby connecting one ear to radio signals and the other to submarine signals.

These signals will also be furnished in clear weather when requested to do so by radio. It is requested that all passing vessels equipped with submarine signal receiving apparatus familiarize themselves with this apparatus and report success obtained to the Hydrographic Office.

Wave-length used is 600 meters.

Watches are stood as follows:

(1) Continuously during thick weather.

(2) During clear weather, first fifteen minutes of every hour from 8 a. m. to 9.15 p. m.

# From and For those who help themselves

Experimenters' Experiences.



The editor of this department will give preferential attention to contributions containing full constructional details, in addition to drawings.

## FIRST PRIZE, TEN DOLLARS The Advantages of a Quick-Acting Hot Wire Ammeter

The difference between the hot wire ammeter that I am about to describe and others designed by amateur experimenters lies in the fact that my instrument has double magnification, while the majority of other designs have single magnification of the expanding hot wire.

Details of the various parts are shown in Figure 1, details of the pointer and axle in Figure 2 and the complete assembly of the instrument in Figures 3 and 4.

The material required for the construction of this instrument is as follows: A piece of brass strip, No. 22 and No. 24 gauge, 8 inches in length and  $\frac{1}{2}$  inch in width; five knurled nuts ( $\frac{8}{32}$  thread); two hexagon nuts ( $\frac{8}{32}$  thread); five machine screws ( $\frac{3}{4}$  inch in length,  $\frac{8}{32}$  thread); 1 length of silk thread; 1 piece of fine wire, preferably No. 36 or No. 40 copper (B. & S. gauge); 6 inches of copper wire (B. & S. gauge, about No. 22); 3 inches of brass wire (B. & S. gauge, No. 22); 12 inches of one ampere of fuse wire (lead),  $\frac{3}{4}$  inches steel rod (1/16 inch in diameter); a small quantity of solder, a piece of Bristol board for the

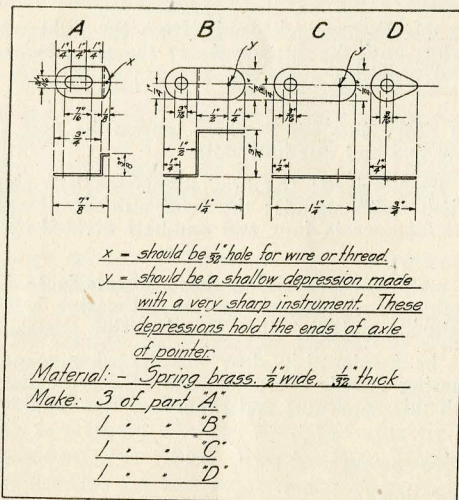

Figure 1, First Prize Article

dial, and a wood or hard rubber base 4 inches by 6 inches by  $\frac{3}{8}$  inches.

The majority of the materials required for the construction of this instrument can be found around the average experimenter's workshop; the remainder can be purchased from any electrical supply house dealing in experimental goods.

To begin the construction of this instrument, cut the brass strip into the shapes shown in Figure 1, drilling holes and slots as indicated. Make three pieces after the diagram A, and one each of B, C and D. The bearings for the axle of pointer (Y in Figure 1) may be constructed by sharpening a nail to a very sharp point, followed by making a slight indentation in the brass where the arrow points, as in Figure 1.

The construction of the pointer follows: Take the No. 22 copper wire and wind about four or five turns on the steel rod, which must have its ends sharpened to a fine point, as in Figure 2. Solder the turns of wire to the axle and leave a thin coat of solder on the drum for the silk thread. Wind a piece of lead fuse wire around the short projecting end of the pointer until the needle perfectly

balances. The pointer end may be beaten into any desired shape by judicious use of a hammer and anvil followed by the use of a fine toothed file. Figure 3 indicates how the pointer is held between the bearings B and C.

The brass wire should be  $\frac{3}{4}$  inches in length with a loop in one end. The other end is soldered to the projecting part of D, as in Figure 4.

The base should be 4 inches by 6 inches by  $\frac{3}{8}$  of an inch and drilled to hold the five bolts, as in Figure 4.

The brass parts are assembled as in Figure 4, the fine wire being soldered to  $A^1$  and  $A^2$ . The slots in  $A^1$  and  $A^2$  should be adjusted to take up the slack in the expanding wire but not to stretch it. Follow this by tying one end of a silk thread, about a foot long for convenience, to a small piece of wire shaped like a hook and place the hook over the expanding wire in the middle. Tie the other end to  $A^3$  to take up the slack. In the middle of this thread tie the end of another thread which goes twice around the drum of the pointer and then is

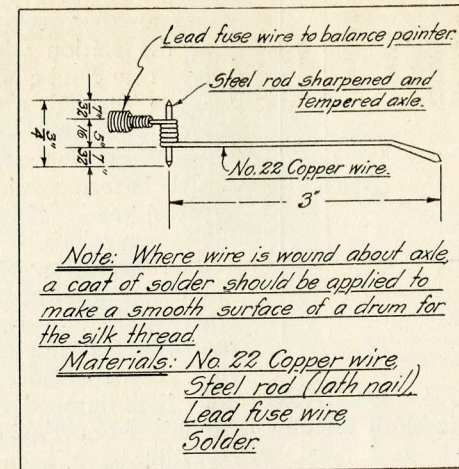

Figure 2, First Prize Article

actual values are desired, comparative values can be obtained without calibration of the instrument. If, however, access can be had to an accurate ammeter of the hot wire type, it may be connected in series with this instrument and the deflection of both pointers noted for given values of current. In this way the entire instrument can be perfectly calibrated. If the hot wire is not able to carry the current output of the transmitter it may be shunted by several small wires until the required current carrying capacity is obtained.

PHILANDER H. BETTS, *New Jersey.*

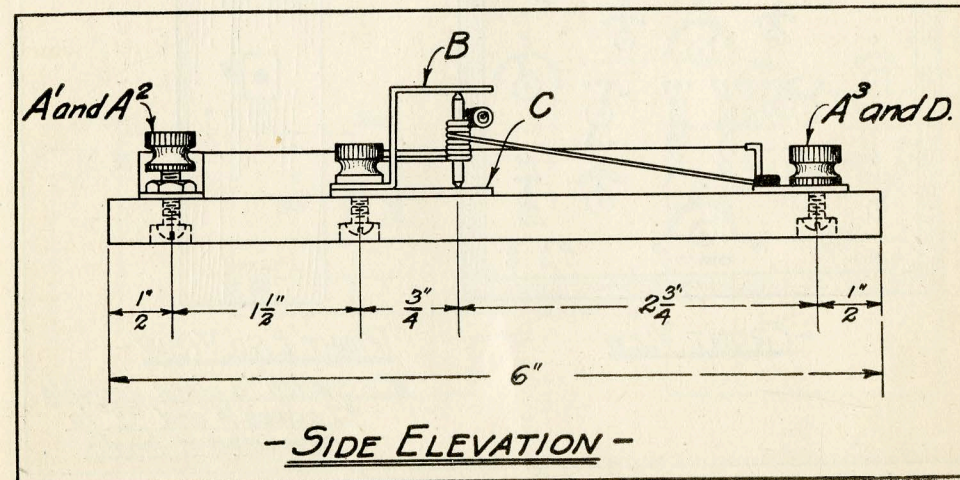

Figure 3, First Prize Article

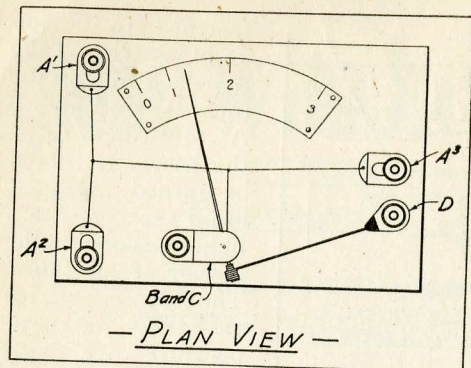

Figure 4, First Prize Article

**SECOND PRIZE, FIVE DOLLARS  
A Receiving Set Which is Well Recommended**

As a general rule cabinet receiving sets are "slapped" together without much thought as to the working abilities of the different instruments included. I might mention at the start that in my opinion a perfect receiving set has not yet been produced, but I thoroughly believe that the one that I have constructed works better than the usual so-called cabinet set. While, of course, anyone can design a receiving outfit, the real object in view should be to improve former types of apparatus in use.

The receiving unit that I am about to

describe has several advantages over the usual amateur sets, one of them being that the station which you wish to receive from can be brought in loud enough to copy through practically all kinds of interference, both local and long distance. In fact stations that I never heard before could be read with the greatest ease. The selectiveness of tuning is marvelous.

The operation of this set is simple. Amateur stations can be read more easily when using the small coupler than with the ordinary coupler in the average station. Furthermore, the equipment will copy both damped and undamped waves. Signals from Tuckerton, Arlington and Sayville have been read repeatedly at Indianapolis, Indiana, using an aerial 300 feet in length and 30 feet in height, consisting of 1 single wire.

The construction of this receiving unit is as follows: The case is made preferably from walnut, although any hard and close grained wood will suffice. It is 16 inches in length, 5 inches in depth and 12 inches in height and is made of 1/2-inch wood throughout.

The front of the set is made of 1/4-inch "Bakelite" the dimensions being 14 inches in length by 10 inches in height. All connections are made through the front.

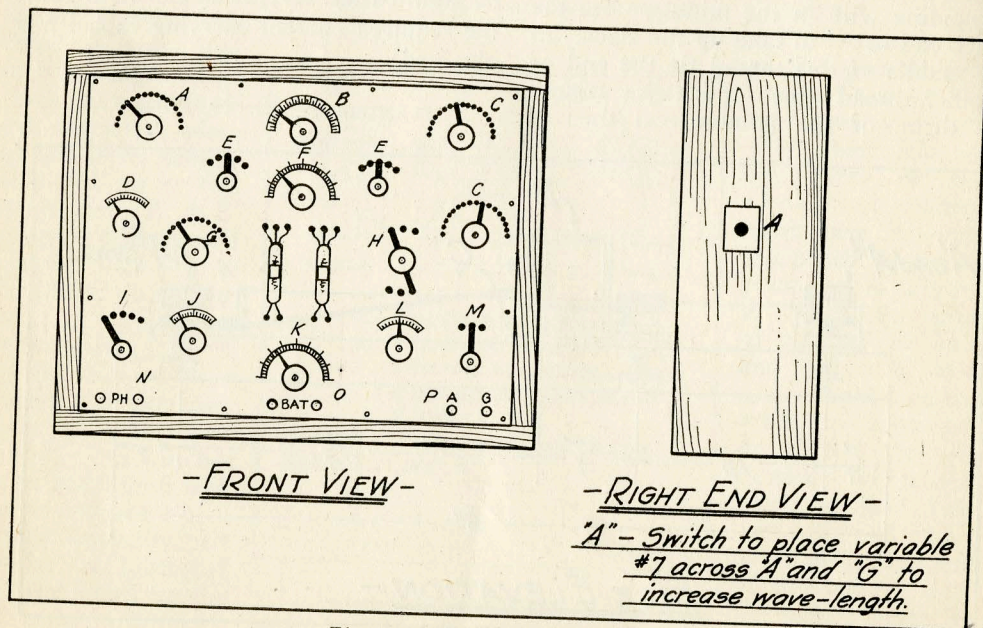

Figure 1, Second Prize Article

**-FRONT VIEW-**  
**-RIGHT END VIEW-**  
"A" - Switch to place variable #7 across "A" and "G" to increase wave-length.

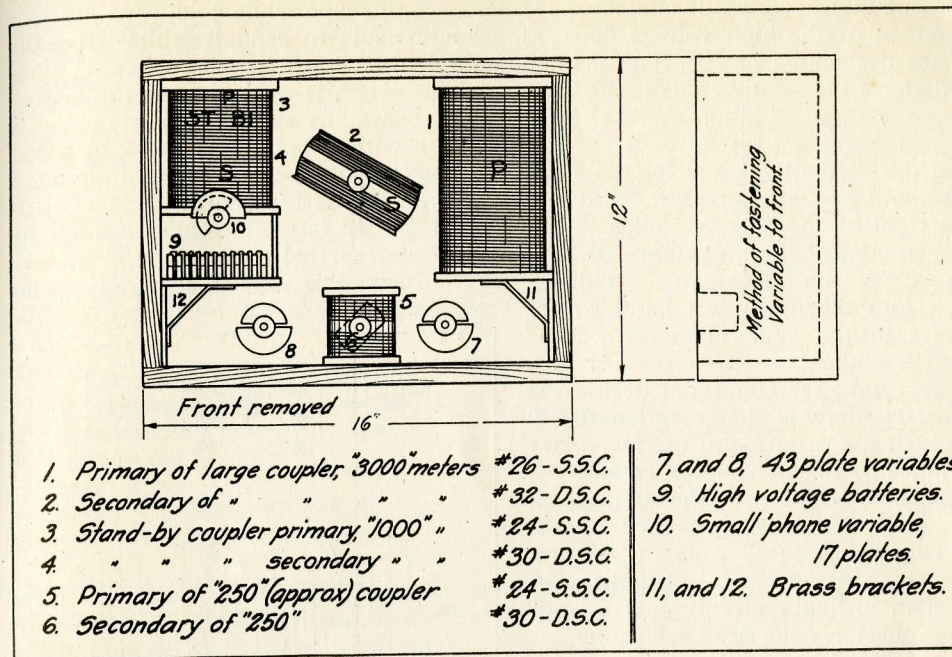

Figure 2, Second Prize Article

The back may be made of any soft wood, such as pine or bass. All other measurements for the construction of this set may be taken from Figures 1 and 2, the latter figure showing particularly the layout of the coils and the relative positions within the apparatus.

An explanation of the notations on Figure 1 follows: A is the upper left hand switch of 20 contacts which controls the "Stdbi" primary winding; B is

a rheostat mounted at the top in the center for controlling the filament current for the vacuum valve detectors; C C are two switches mounted at the extreme right, one above the other, which control the inductance of the large loose coupler. There are 20 contacts on each switch. D is a variable condenser placed on the extreme left at the middle and is connected across the head telephones.

The two 5-point switches above and at

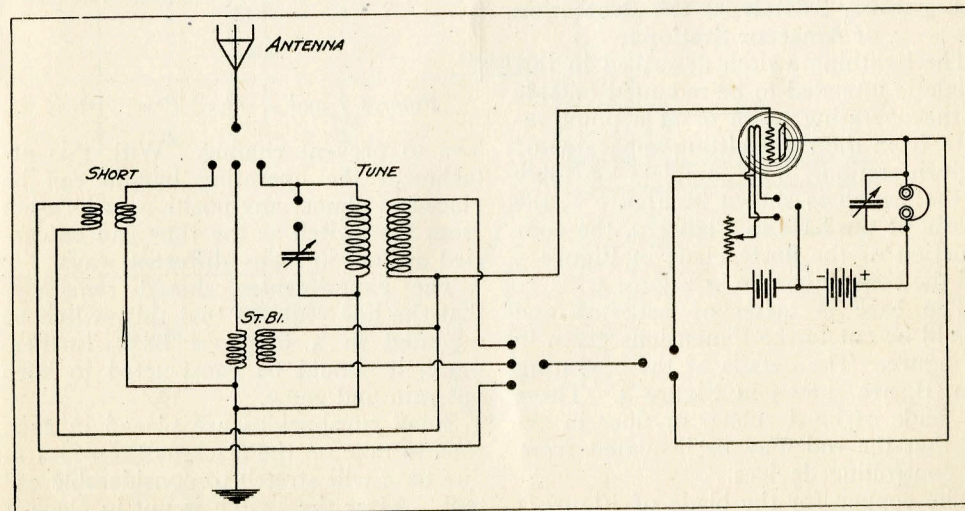

Figure 3, Second Prize Article

the side of the vacuum valve detector are for control of the high voltage battery; they are designated at E. F is a knob placed above the vacuum valve which rotates secondary winding of the large loose coupler. The switch, G, at the left side of the vacuum valve is for the small coupler and has 20 contacts. Switch H at the right of the detector bulbs is employed to control the inductance of both the primary and secondary windings. Switch I in the lower left hand corner connects in the four filaments of the various vacuum valve detectors; J is a variable condenser connected across the primary to increase the wave-length; K is a switch for variation of the secondary inductance of the small loose coupler; L is a variable condenser on the right which is in series with the secondary of the large coupler, or small coupler. M is a switch to change from the "amplifying" to a plain ordinary circuit. At N two binding posts for the head telephone are shown. The low voltage batteries attached to the middle lower binding posts at O and the lower right hand binding posts are for the aerial and earth connections.

I believe that any amateur undertaking the construction of this outfit will be amply repaid for the time and money spent. I should like to hear from experimenters as to the results obtained.

M. B. LOWE, *Alabama*.

### THIRD PRIZE, THREE DOLLARS A Lightning Switch for the Protection of Amateur Stations

The lightning switch described in this article is intended to be mounted outside of the operating room or at a point remote from the transmitting apparatus of a given station. The complete assembly of the switch is shown in Figure 1, the details of the base in Figure 2, the construction of the knife blade in Figure 3 and the control handle in Figure 4.

The base is made of asbestos and should be cut to the dimensions given in the figure. The details of the operating arm, B, are shown in Figure 4. These are made of hard rubber or fiber in order that the rod may be insulated from the controlling devices.

The copper for the blade of Figure 3

is bent to shape while cold. No attempt should be made to bend it while hot as it is apt to snap off.

The switch is worked from the instrument board, as shown in Figure 4. A handle with a pointer is fitted to a  $\frac{1}{4}$ -inch shaft with a wooden drum mounted on the back of the board. A  $\frac{3}{16}$ -inch braided rope is next wound around the drum and carried over to the insulators B. In case this rope is required to run around corners it can be placed on pul-

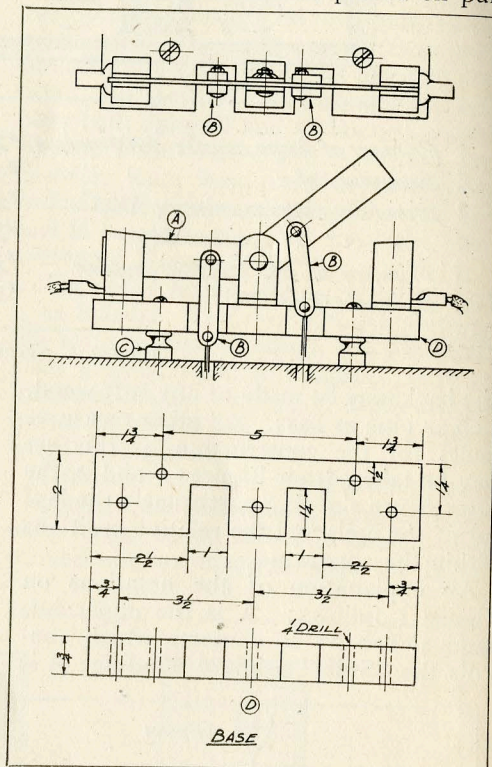

Figures 1 and 2, Third Prize Article

leys to prevent chafing. With this attachment the operating handle can be placed in almost any position or location from the switch as the rope can be carried around in many different ways.

The experimenter should remember that the law requires that this switch be mounted in a fireproof box; furthermore, it should be constructed to keep out rain and snow.

Small turnbuckles are placed in each rope to take up the slack as the ropes in due time will stretch to considerable extent. After the switch is put in place it

requires no more attention and by a slight turn of the handle on the instrument board can be thrown in either the sending or receiving position. With a switch of this type installed in a station, the experimenter need not fear approaching thunder showers, nor is he required to endanger his life by contact with the knife blade.

O. E. COTE, *Rhode Island*.

### FOURTH PRIZE, SUBSCRIPTION TO THE WIRELESS AGE A Portable Receiving Cabinet for Amateur Hikes

An inexpensive receiving set that requires a small amount of space, making it particularly suitable for travelling and Boy Scout hikes, is shown in the accompanying drawings, Figures 1 to 5. It is so small that it can be carried in

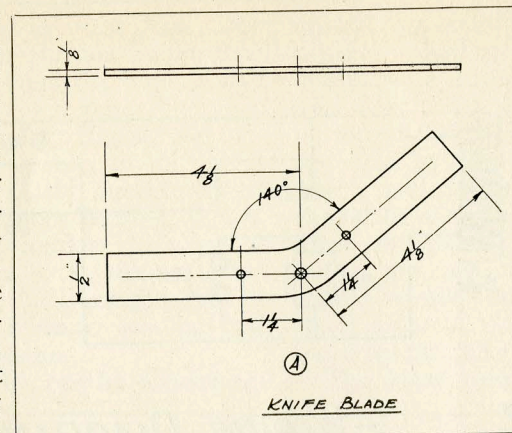

Figure 3, Third Prize Article

inches in height. The material is  $\frac{1}{4}$ -inch wood veneered to a high polish. The top of the box is held secure to the sides by small round-head brass wood screws, about eight in all being required.

The next in order of construction are the knobs for the primary, secondary and loading coils. These are made of  $\frac{1}{4}$ -fiber of vulcanized rubber cut out through a diameter of  $2\frac{1}{4}$  inches as in Figure 2. These knobs can be turned out with a lathe or by hand by means of a hack saw. A hole is drilled in the cen-

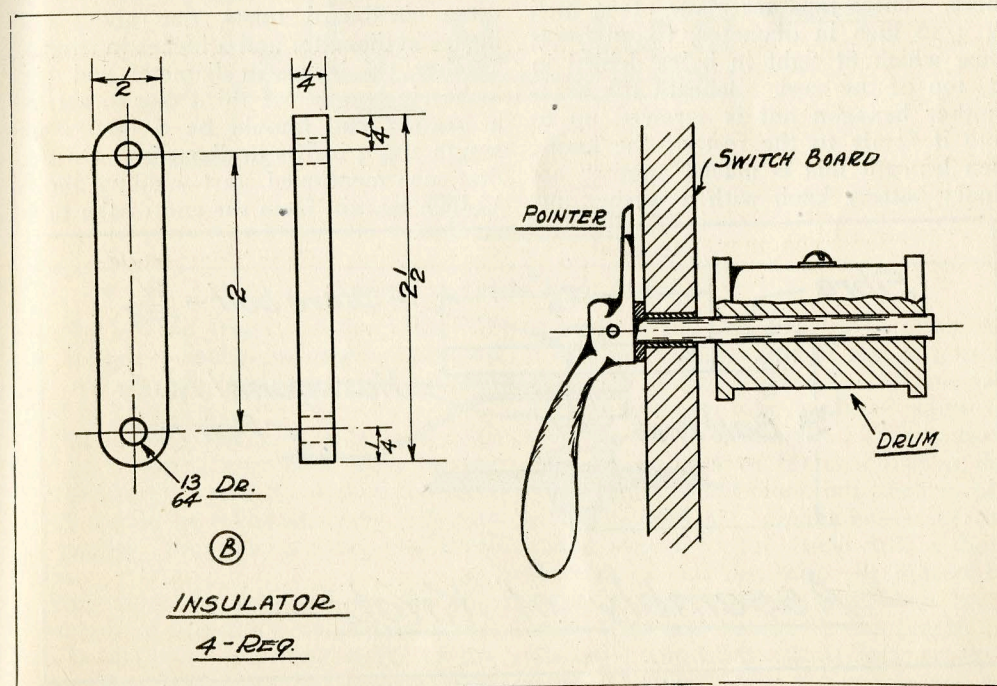

Figure 4, Third Prize Article

the corner of the motor-car or on the rear of the motorcycle without occupying any notable space. The majority of dimensions for this set are given in the accompanying sketches. A description follows:

The first step of the construction is the box or case, which has dimensions 10 inches by 10 inches by  $4\frac{1}{2}$



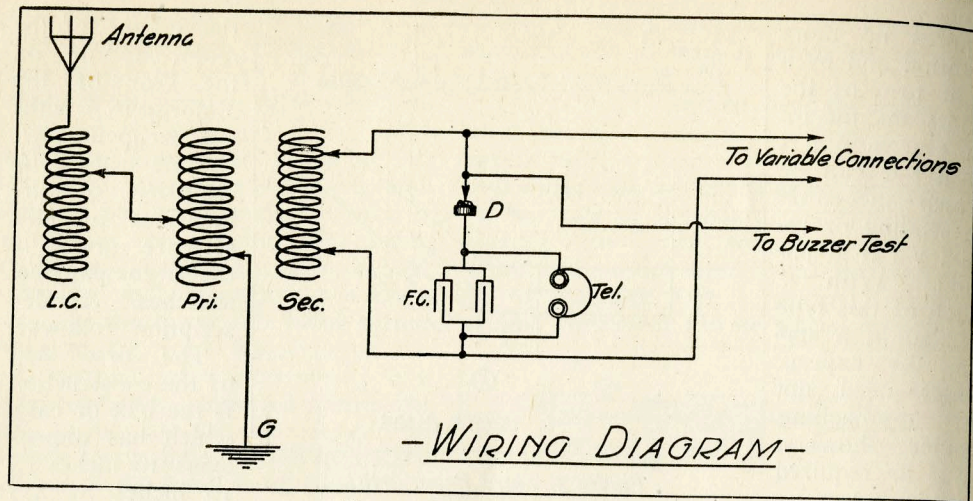

Figure 1, Fourth Prize Article

ter to let an 8/32 stove bolt pass through snugly; then a hexagon nut is screwed up securely against the fiber or rubber to hold it firmly to the bolt. Follow this by securing a piece of spring brass about 2 1/2 inches in length and approximately 3/4 inches in width; then drill a hole so as to let the stove bolt pass through it tightly. Bend the brass in a suitable position to come in contact with the taps or points which are connected to the primary, secondary or loading coil inducances. These taps are made of 5/8 inch by 3/16 inch in diameter, round brass rods, which fit tight in holes drilled in the top of the case. Beneath the brass another hexagon nut is screwed up to hold it firmly to the rest of the knob; then beneath this is placed another ordinary battery knob with a washer un-

derneath so that the knob can turn freely on the top of the case. Another washer is placed on the bottom below the top of the case followed by placing another nut in position. The terminal wire is soldered to the latter washer and the knob is thus completed.

The next step is the construction of the coils. The primary is wound with No. 22 enamelled or cotton covered copper wire, which can be procured at any electrical dealer. Then secure about three cardboard tubes, one about 3 3/4 inches in diameter and 4 inches in length, another 3 5/8 inches in diameter and 3 3/4 inches in length. A third one to act as a loading coil should be 6 inches in length and 3 inches in diameter. On the first tube mentioned start winding about 1/2-inch margin from the end of the tube

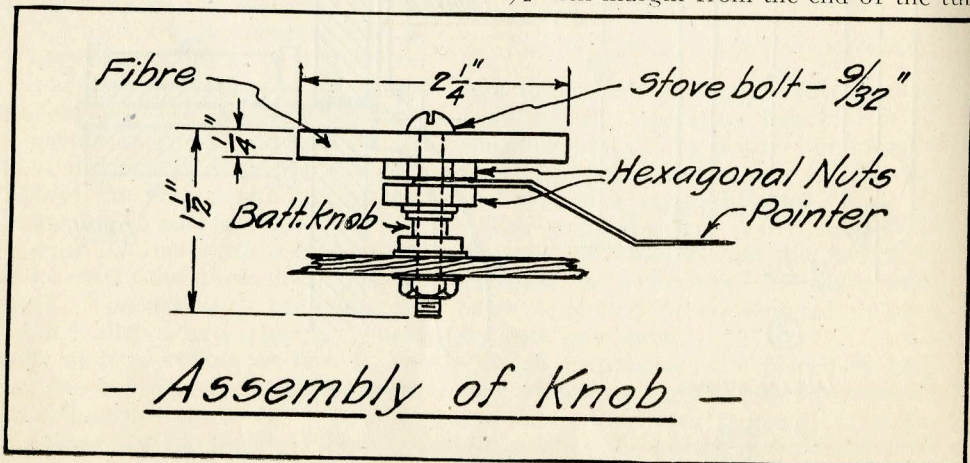

Figure 2, Fourth Prize Article

and take off a lead at every turn. Repeat this operation for ten consecutive turns. After this wind the wire around the cardboard tube ten times and then take off a connection. Repeat this operation until the extremity of the coil is reached, leaving 1/2-inch margin as at the start. The primary winding is now complete. The secondary winding is made of No. 30-32 or 34 silk or cotton covered wire. A little margin can be given as in the primary winding and the winding then begun.

As noted, the taps can be divided ac-

an old one microfarad telephone condenser. First cut out a strip of paraffine paper a little longer and about one-half inch wider on each side; then lay on top of this a piece of tinfoil and follow this by another piece of paraffine paper, and so on. These tinfoil strips should be about 20 inches in length and after all pieces of foil or paraffine paper are put in position, the units should be rolled up in circular form. Two small strips of tinfoil should be brought out from the roll for external connection.

The loose coupler must be fastened

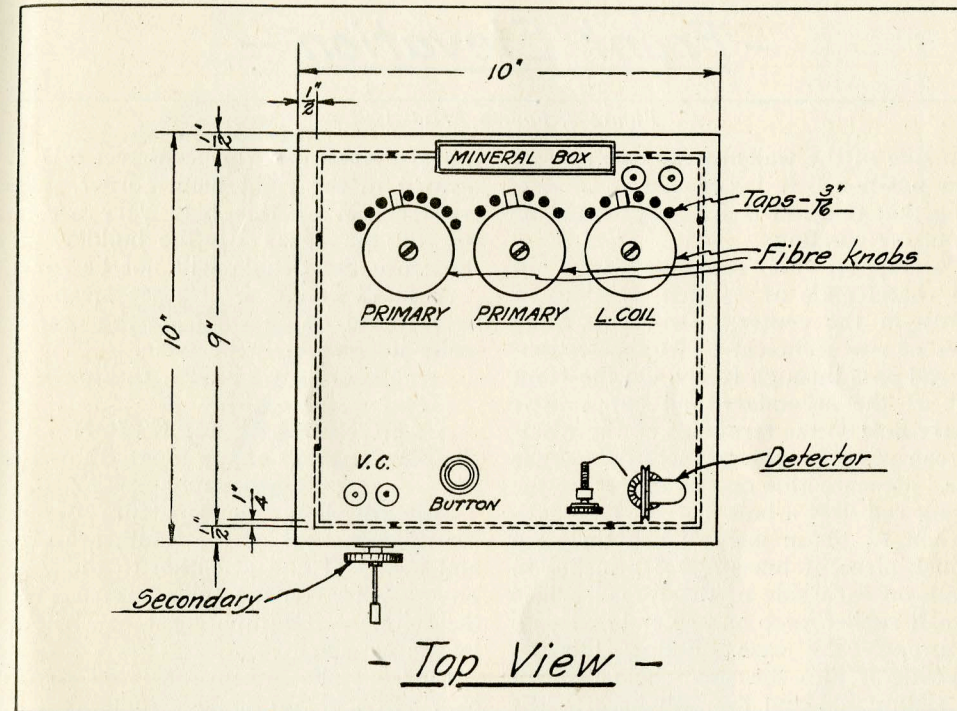

Figure 3, Fourth Prize Article

ording to the length of the tube. If the tube is 6 inches in length, take one tap every inch and the winding will then be complete.

The loading coil can be wound with No. 22 cotton or enamelled wire, leaving a little margin from the end of the tube. Taps should be taken at every inch and a quarter, thus completing the three coils.

This is to be followed by the construction of the fixed condenser which can be made of two long strips of tinfoil. The latter can be secured from

securely to the case and it is best to place it on the left hand side of the case as is shown in sketch Figure 5. At one end of the primary tube a round piece of wood is cut to fit snugly. This is fastened to the back of the case and at the front end a small block is placed in position to hold it. In the center of the round board in the back drill a hole through it and the case. It should be large enough to admit a 1/4-inch brass rod. The rod should be the length of the case, projecting out 1/4 inch on each side. It should have a hexagon nut on

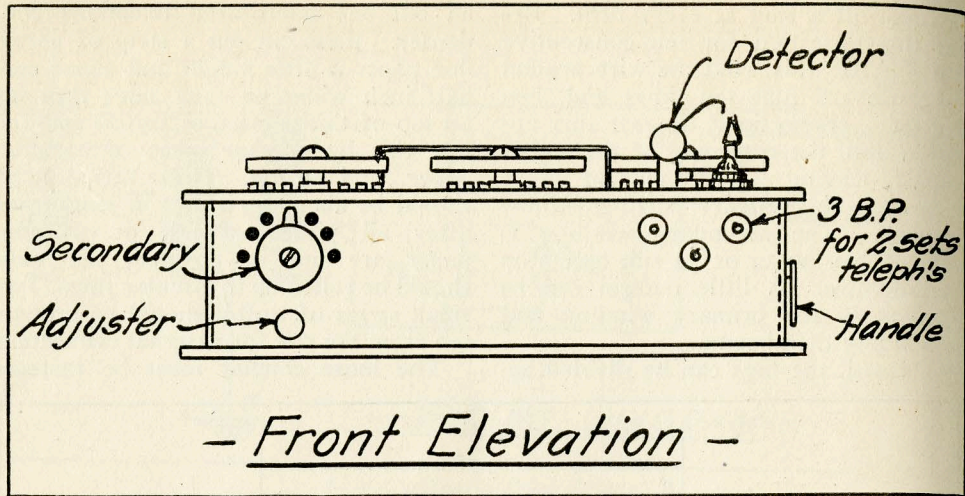

Figure 4, Fourth Prize Article

each side of the walls of the box to hold it in position. It is, of course, understood that this rod is for support of the secondary winding.

To support the secondary tube cut two round ends of 1/4-inch wood to fit tightly in the center. Drill two large holes of size sufficient to let the stationary rod pass through freely. On the front part of the secondary end cut a little square hole so the terminals of the winding can pass through to the front of the case. Beneath this on the center of the sliding rod drill a hole a slight bit smaller than 1/8 of an inch. Then thread a 1/8-inch piece of brass about 5 inches in length on each side of the thread. Place a small rubber knob on one end and pass it through the case. Follow this by screwing it into the small hole beneath the sliding rod and the adjuster for the position of the secondary winding is now complete.

It will be noted in Figure 5 that a small test buzzer is mounted inside the cabinet. This is placed in inductive relation to some part of the receiving circuit in order that the sensibility of the receiving detector may be determined. Also in Fig-

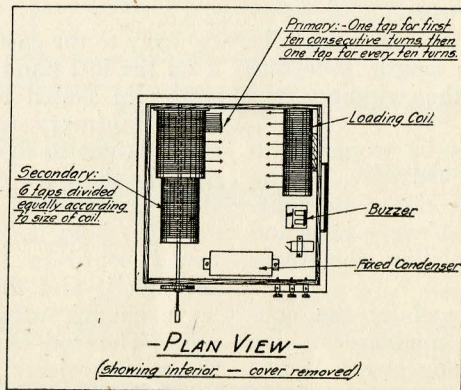

Figure 5, Fourth Prize Article

ure 3, a small cat-whisker detector is indicated in the right hand corner. The construction of this may vary according to the ideas of the builder, and therefore the details will not be given.

A small handle or leather strap can be fastened to one side of the case to make it completely portable.

EUGENE LE FEVRE, California.

### HONORARY MENTION An Explanation of the Mast Shown in Photographs

Just to show the amateurs of the North that those of the South are alive and awake, I call attention to the three photographs (on the following page) of the wireless telegraph mast constructed by me personally.

Figure 1 shows a nearby view of the base and will aid some in obtaining an idea of how it was erected.

Figure 2 shows in detail the base and a section of the mast, while Figure 3 gives all details, from the top of the base to the top of the mast itself. This mast has just been completed and as soon as the aerial is in place I expect to work.

AUBREY WHITNEY, Alabama.

### HONORARY MENTION An Efficient Earth Connection and How to Make It

The average amateur earth connection is inefficient, but this is not surprising when we consider the time taken by the average experimenter to effect an earth connection. I have often wondered why such experimenters do not take plenty of time and secure a more perfect earth connection. Certain amateurs simply

soldered properly and also the pipe possesses many high resistance joints before it reaches the street water mains, thus causing a considerable loss in current. Again, the pipes often run a short distance through the building where they are connected to a large pipe through a rubber gasket. This would almost prevent the passage of current coming in direct contact with the earth and would introduce a certain amount of re-

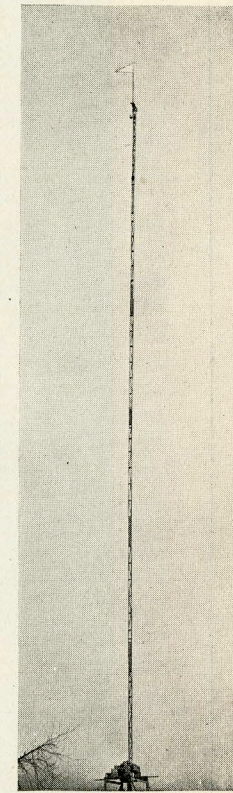
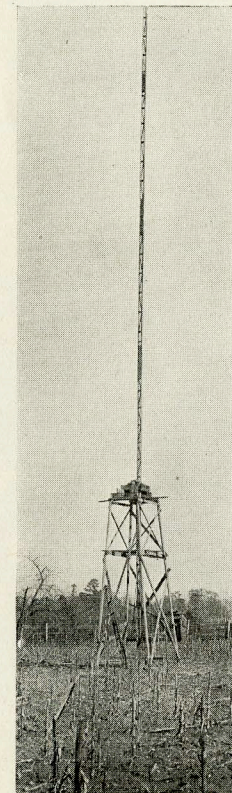
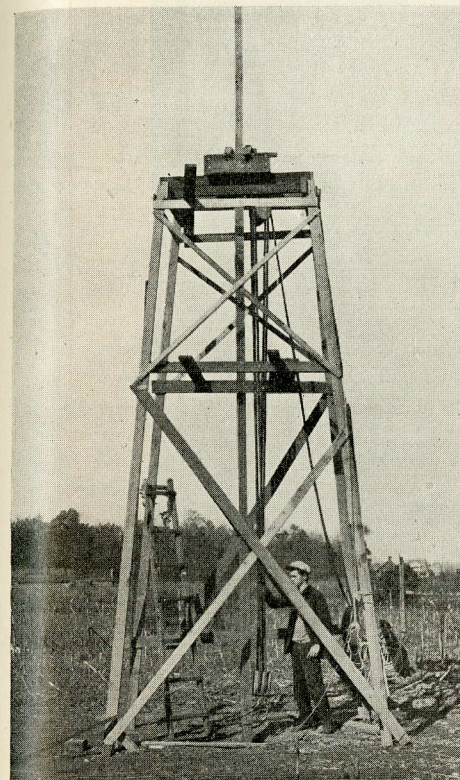

Figures 1, 2 and 3, Honorary Mention Article, Aubrey Whitney

drive a pipe 5 or 6 feet in the earth and expect to work to a great distance. A ground connection of these dimensions is exceedingly inadequate for any amateur station and effort should be made to construct one of greater current carrying capacity and earth surface contact.

The amateur is accustomed to attach the earth connections to the gas or water pipes in the house, but nine times out of ten, the connection to the pipe is not

distance in the circuit which would be detrimental to its efficiency. Also, the average steam or water pipe connection runs a considerable distance before making actual contact with the earth and therefore considerable current is lost en-route.

A gas pipe should never be used for this connection as there are rubber

(Continued on page 450)

## N. A. W. A. National Chief of Relay Communications



William H. Kirwan (9XE), N. A. W. A. national chief of relay communications, was born in Baltimore, Md., February 5th, 1881. He was graduated in steam and electrical engineering from the Baltimore Polytechnic Institute, class of '97, and two enlistments in the United States Navy as electrician gave him additional training. Six years' study of law at Baltimore Law School and Baltimore University fitted him for the bar, but he took up engineering instead and became assistant erecting engineer at the Panama Canal for the machinery installed on all "emergency dams." He has long been a student of wireless. Mr. Kirwan is now employed as superintendent of construction for the Otis Elevator Company of New York in the states of Iowa and Illinois.

# A Coast-to-Coast Relay

Comprehensive Plans for Interchanging Messages Between the Mayor of New York and the Chief Executives of Other Cities Under the Auspices of the National Amateur Wireless Association

By 9XE

*National Chief of Relay Communications*  
NATIONAL AMATEUR WIRELESS ASSOCIATION

A WIRELESS race will start from New York City on the night of Saturday, February 24th, after the NAA report. A message will be sent from the mayor of New York to the mayor of Los Angeles and all West coast cities possible. The stations handling this MSG westward will be special stations which will receive and QSL the MSG in regular order if possible. If the operator of a station farther down the list gets the MSG ahead of time he should wait until he has been called by the station preceding him before sending. This relay will be conducted under the auspices of the National Amateur Wireless Association, but will be open to all.

A return MSG will be ready in Los Angeles and Seattle. Only amateur stations will be used on the route East, the plan being to deliver the return MSG from the West coast to the mayor of New York. Both special stations and amateurs will be working against time. The time of sending the MSG East or West will determine which class of stations will be declared the winner.

All of the best special and amateur stations in the United States are entered in this relay. As many amateurs have complained that all of the preceding relays have been easy, only the names of the sending stations in this event are made known, neither the exact time nor the wave-lengths being revealed. This plan will serve to insure quiet and will also provide opportunity for practical work in locating the points on tuners where the sigs from the various sending

stations are QSA. The sending stations, however, will receive printed instructions by mail before the relay, giving the wave-length, power, etc.

The MSG will start from station 2ZK, New Rochelle, N. Y. George C. Cannon, the owner of this station, has consented to arrange the details of the event in the East, as well as start the relay. The time will be about half past ten o'clock at night. The following stations will be called, each in turn calling the next station on the list. If the next station has already received the MSG ahead of time, the operator should indicate this fact by calling CK—QSL and then call the next station on the list.

Station 2ZK calls 8YI, but if QRM is bad, station 3ZS will QSL 2ZK and then call 8YZ, who will in turn call 8YO. This will eliminate 8YI. Both 3ZS and 8YZ should be very careful not to QRM 8YI, but give time for checking. 8YO calls 8YL, who in turn calls 9ZS and 9ZN. 9ZS and 9ZN will listen for each other's CK and if 9ZS gets the MSG he will call 9XV and 8XA, giving the MSG to both of them at the same time.

If 9ZS does not get the MSG, 9ZN will give it direct to 9XN and 8XA will repeat the MSG only once after 9ZN, so that there will be no doubt that 9XN and 9XV have received it. 9XN will give the MSG to 9ZF and if there is any QRM 9XV will give it to 5ZC. The latter will in turn give it to 9ZF who will in turn give it to the West coast, landing the MSG direct at 6EA.

It is planned to have 8XA give the

MSG only once if possible, as it is likely he will be heard on both coasts. 9XV and 9XN should have no trouble in getting the MSG direct from 8YI if he sends, but in case he does not it will be better to follow the schedule. Here is the schedule simply explained: 2ZK, 8YI, 8YO, 8XA, 9XN, 9ZF to the coast; or, in the event that 9ZS receives the MSG from 8YL, 2ZK, 8YI, 8YO, 8YL, 9ZS, 9XV, 5ZC, 9ZF. In either event 8XA will repeat the MSG after 92F has it. Haig and Smith, in Denver, will have no small task on their hands and 8XA will probably be heard in the Northwest by 7DJ and 7YS who are anxious to get the MSG. They are practically cut off at present because of the fact that Campbell, in Lewiston, Mont., and Heacock at La Grande, Ore., are out of commission.

The stations in the Southern States should not send during the relay, being requested to wait until 9ZF has the MSG before manipulating their keys B. Martin, of Mobile; W. Horner, of Cleveland, Tenn., and W. Anthony, of Shreveport, La., together with the Rev. Philippe, of St. Charles' College, have been requested to check all special stations and, if possible, make reports showing the relative strength of sigs of all special stations heard, using the weakest signals as a standard.

Seefred Brothers, 6EA, Los Angeles, have agreed to co-operate with the writer in handling the details on the West coast and the return MSG will be arranged for ahead of time and returned to 9ZF as soon as they have received the westward MSG.

The sending stations for the eastward MSG will be as follows: 6EA, 6DM, 9ZF or 9AMT, 5DV, 9ABD, 9GY, 8AEZ, 2AGJ, 1IZ, 1ZM. The route may be slightly changed from 6EA to Denver.

On the return SG after 1IZ has given QSL, station 8NH (Mr. and Mrs. C. Candler), will be asked to send the MSG two or three times on QST for the benefit of the amateurs on the East coast who will listen for this station and also the westward MSG after 9ZF has received it.

9ZN will be asked to test the efficiency

of his Mississippi River route to the Gulf by getting the MSG in every city south of Chicago on February 25th, starting at ten o'clock in the morning.

A number of wireless policemen or monitors of the air have been appointed and they will report those who send without authorization during the relay. Amateurs should have the MSG delivered to the mayors receipted for. The time that they, as well as the mayors receive the MSG should also be indicated on the MSG. Reports on what was received should be sent to 9XE, Davenport, Ia., not more than forty-eight hours after the night of February 24th. If the letters are delayed it will be impossible to publish the names of the writers.

Prizes will be awarded for quick reception, long distance reception and delivery of both messages. A partial list of the prizes follows:

First prize, 1 k. w. transformer, Thordarson Company, Chicago; second prize, 1 749 tuner, F. B. Chambers Company, Philadelphia; third prize, 1 Arlington tuner, W. B. Duck Company, Toledo; fourth prize, 1 pair 3,000 ohm phones, Mesco, Chicago; fifth prize, 1 wave meter (\$8.00), Electro Importing Company, New York.

Henry W. Blagen, of Hoquiam, Wash., has arranged to send a message from the mayor of Seattle to the mayor of New York. The amateur picking up this message and starting it East will receive a prize. Prizes will be given to amateurs only.

9XE of Davenport, is having a handsome silver cup properly engraved to present to the operator of the best all-around station excelling in sending and receiving records in the relays this year. Opportunity will be given every year for others to contest for possession of the cup.

The names of the assistants in the relay are as follows:

G. C. Cannon, 2ZK, New Rochelle, N. Y.; Professor Blatterman, 9XV, St. Louis, Mo.; Professor Taylor, 9XN, Grand Forks, North Dakota; E. F. Doig, 9ZF, Denver, Colo.; W. H. Smith, Our Old Friend Mac, 6SH, Stockton, Cal.; Seefred Brothers, 6EA, Los An-

geles, Cal.; G. F. Johnson, 9ZS, Illinois Watch Company, Springfield, Ill.

The following stations have been requested to act as wireless policemen and report all QRM, which will be published: V. C. McIlvaine, 4CT, Tampa, Fla.; F. F. Merriam, 4CL, College Park, Ga.; W. S. Rothrock, 4DL, Winston Salem, N. C.; W. T. Gravely, 3RO, Danville, Va.; C. R. Lamdin, 3ME, Baltimore, Md.; F. B. Chambers, 3XC, Philadelphia, Pa.; C. D. Tuska, 1ZT, Hartford, Conn.; Sergeant Pearce, 2ZA, New York Police Department, New York;

Cornell University, 8XV, W. C. Ballard, New York; South Ohio Radio Association, Cincinnati, Ohio; H. C. Colburn, KIY, Victor, Colo.; Professor A. H. Ford, 9YA, Iowa City, Ia.; R. W. Weitz, 9SK, Des Moines, Ia.; H. H. Shotwell, 9EF, Chicago, Ill.; Harmon Deal, 9NN, Cape Girardeau, Mo.; J. M. Clayton, 5BV, Little Rock, Ark.; D. R. Simmons, 5AX, Shreveport, La.; O. R. Terry, 9HQ, Stoughton, Wis.; H. W. Blagen, 7DJ, Hoquiam, Wash.; R. Higgy, 6DM, Phoenix, Ariz.; W. S. Ezell, 9YE, Wichita, Kas.

### In Complimentary Vein

What there is in THE WIRELESS AGE you may be assured you can rely upon. It is in a class by itself.—H. M. C., *Maine*.

I am very much pleased with your magazine and find many useful hints that help to add to the efficiency and looks of a station.—M. E. N., *North Dakota*.

Please renew my subscription. Please send the Year Book and "How to Pass U. S. Government Wireless License Examinations" *at once*, as I NEED them.—R. B., *Ohio*.

One of the best, if not the best magazine dealing with radio, that is published.—L. E. B., *Montana*.

### SPEAKING OF THE N. A. W. A.

Those MONTHLY SERVICE BULLETINS are great.

L. MASON, *Minnesota*.

I received my equipment and now wonder why I had not joined the N. A. W. A. before.

JOHN J. SULLIVAN, *Rhode Island*.

I am very proud to belong to the Association.

JOSEPH O'CONNOR, *Minnesota*

I am delighted with my equipment.

N. R. BENOIT, *Washington*.

The MONTHLY SERVICE BULLETIN is excellent.

PAUL J. RASMUSSEN, *Wisconsin*.

The pennant, books and pin are worth more than the price I paid for them.

PAUL G. SINGLETON, *Indiana*.

### WILSON FLASHES MESSAGE TO SAN DIEGO

President Wilson, on January 26 sent the first wireless message from Arlington to the new naval wireless station at San Diego, which forges another link in the chain of radio stations connecting American possessions by wireless with Washington. Greetings were flashed by the President to the new station, and an answering message was almost immediately transmitted from San Diego.

The new San Diego station will, according to published plans, permit of

direct radio communication between the Atlantic and Pacific coasts, and will serve as a relay station for transmission of messages from Washington to the wireless stations at Pearl Harbor, in Hawaii, and at Cavite, in the Philippines, which are now in course of construction. The San Diego station will be able to communicate directly with wireless stations on the Panama Canal and in Alaska.

## A Song of Wireless

Tah-daah-dah-dah, the king am I, the monarch of today;  
 O'er earth and air and sea and sky, I hold unquestioned sway  
 My Mercury-shaming couriers spring up from every clime,  
 Turn night to day, and laugh away the threats of Father Time.  
 From Eiffel's lofty reaches,  
 To Poldhu's lonely beaches,  
 From Sayville down to Arlington, across to Frisco town,  
 Honolulu, Yokohama  
 From proud old Fujiyama  
 To Hong Kong and Vienna, men do homage to my crown.



Tah-daah-dah-dah, the superposed gray bulldogs of the sea;  
 Loose triple-gun damnation at a word of code from me.  
 My crackling spark gaps guide aloft the swooping aeroplane,  
 And far below, with decks awash, the deadly submarine,  
 They solve the ether's mystery  
 They write the page of history.  
 And when, a thousand miles at sea, comes sudden grim distress,  
 Trim liners melt their funnels,  
 Lazy trampers drown their gunnels,  
 As they speed "Four bells," in answer to my ringing S. O. S.



Tah-daah-dah-dah, I tell the world of sorrow and of mirth,  
 With Wall Street stock quotations flanked by news of death and birth,  
 My messages are broadcast—seek not a chosen few,  
 But fall alike upon the ears of Christian, Pagan, Jew.  
 I span the racing oceans,  
 Safe from their wild emotions,  
 And I flout the booming breaker as he rages far below;  
 I join the hands of nations,  
 In firm, newborn relations;  
 I unify the universe; I'm king—King Radio.

—V. C. Jewel in *Leslie's*.

## An Idyl of KPH

By Edward Walden

HE was being broken in for the third trick at KPH. Everything was new and interesting and he listened with close attention to the instructions of the regular operator. With delightful anticipation he looked forward to the time when he would be alone and in charge.

The hours wore away. Press was finished, the trans-Pacific boats had cleared and as he sat listening in with the other operator his mind had an opportunity to dwell on the other side of the picture.

A howling southeaster was blowing, shaking the building and straining the cables which held it on the hillside. He began to think that perhaps he would not fancy being alone in that isolated place in the dead of night. When he thought of that long black box in the little back room he concluded that this was well named the "graveyard watch." Why had they put the transformer in a case so suggestive of our last and final habitation? He could not get it out of his mind.

Suddenly he was startled to find that he was alone. Only one pair of phones was connected in and that pair was on his own head. Evidently he was the operator in charge. The wind had subsided and everything was still. The door to the little back room was open and the thought of that long black box came to his mind. He heard the cracking of wood and knew instinctively that a figure was emerging from the transformer case. A shuffling sound, a footstep and an aged man stood in the doorway. Reassured by his harmless appearance, the young operator asked him what business brought him to the station. The visitor pointed to the phones and said:

"With those instruments, you hear the signals which your ears cannot discern, but I have a pair of glasses which will

enable your eyes to see the sparks as they fly through space."

He took a pair of dark colored spectacles from his pocket and handing them to the young man said:

"Come outside and put them on."

Stepping out into the clear starlit night the operator adjusted the glasses and instantly the sky was filled with balls and streaks of fire. As he looked more closely he observed that they moved in trains in different directions. There was a brilliant series coming over Twin Peaks from the north, both balls and bars looked to be a foot in diameter and followed one another at irregular intervals. He soon realized that the balls were dots and the bars dashes and found that he could read them.

He spelled out:

"Don't x JJC msg's. can cpy direct. KET"

Turning to the East, the plain covered by Berkeley and Oakland was a series of small spouting craters. He read a few of them, but they all seemed the same:

"How is my spark. Where are you located plse."

Coming over the Berkeley hills was a scintillating continuous streak of pulsating fire which he could make nothing of. The old man noticed his perplexity and handing him another pair of glasses said:

"Try these. The alternations are too rapid for the pair you have on." The young man changed the glasses and saw the continuous streak as balls and bars connected by a hazy arc. He read:

"We lsn fer u at 6 am—WGG"

He changed the glasses again and looking South was confused at the numerous trains of flying sparks. He tried to read them and this is what he got:

"Arrivals Nera at-50 lbs cabin coffee ten cases milk-clear nw 1 48—we know you are brainless or you would not interfere with a commercial station—terribly lonely without you—two gunners mates second class ten ordinary—903 miles south—hatch no 5 764 bags coffee—ten pound boy—flag fgyq, drtw, fynt, brqx,"—

He gave it up and turned seaward. A number of the fiery trains from the West were traveling slowly; evidently their force was spent. He read one, "RAS de JOC," just before it dropped into the sea.

Looking up at the aerial above his head he found it curious to watch the balls and bars strike the wire and run down the leads like billiard markers. Four balls followed by two balls now struck the aerial but instead of following the leads down, they clung for a moment then dropped on his head. He felt himself clutched violently by the arm and the voice of the regular operator said with a growl:

"The first thing to learn on this watch is to stay awake."

#### ANOTHER LETTER TO MR. MARCONI

Sir: I am intrested in the making of a wireless device for the long distance reading of books and papers by the use of sound. It is the use of the echo you start wuth a voilin. The sound of the voilin will throw the sound of the letters to the voilinst or in any direction that you wiish to. That is take letter A. The letter s sound can to form avocal sound of the letter and can be made to its so that crry through awall. The volin can be made to form the sound of the letters and the sound of the voilin will cary the raeding sound of them as long as them as long of the voilin will cary. I have found that a common standard size of print will throw so a common standard size of print will throw sound to the distance of ten miles to a locomotive whistle where I could here it at this distance. I have this facty pretty well worker in I worked with the use of a hanner so I could read a book with book closed at the distanceof a hundreds of yards. How to get this device worked and made with the use of machenery. It is a good thing for the long distance spyinging on the enemy. One could discover them at the distance of at least fivty miles and all that they knew. In an airoplane it would be more easy. This thing will work specially good a dark nught when there is stormy weather. I have studied this thing with the following tipes of sound, steam whistel, locomotive running, heavy machenry, automobile, street car ponograph, and in fact all types of soound, it might possabe to make sonding and receiving apparatus for the use of electriscity, the use of heavy gun fire sound could be made use of preety easy. I can spy up all sorts of people on both sides of a road for hall with a common motorcycle makeing a recier with sound for thesporous. This can all be made to work a return. The sound is sent by the echo from tyhe surface or edge of thes letters of the alfibet. First learn to throw the spoken sound of the letters o of the alfibet. First learn to throw the spoken sound of the letter a sound reflect. The idea is use the echo for this. With a fiddle you can go through any book with a fiddle and it will you wall want find out about this method of discovery. It is possed with the edge of a pace of cards to discover all that is in the pack of cards. It is pssable to get any sort of a sound or ecow return one experiment that I tried was the efect of an automobile sound thrown to a twig the automobilest able to get a complet return from the book to the automobilest and haveing no sight of the book.

Another way is to wacth to spy with. A wacth will go thruh any kind of a book. A man could go throuh your premissis and get ahold of every thing that you had on them and you never find it out. In this way forign spy trains himself to find out every thing that is around him. This sound is a good thing as it tells you the principl of the thing.

## With the Amateurs

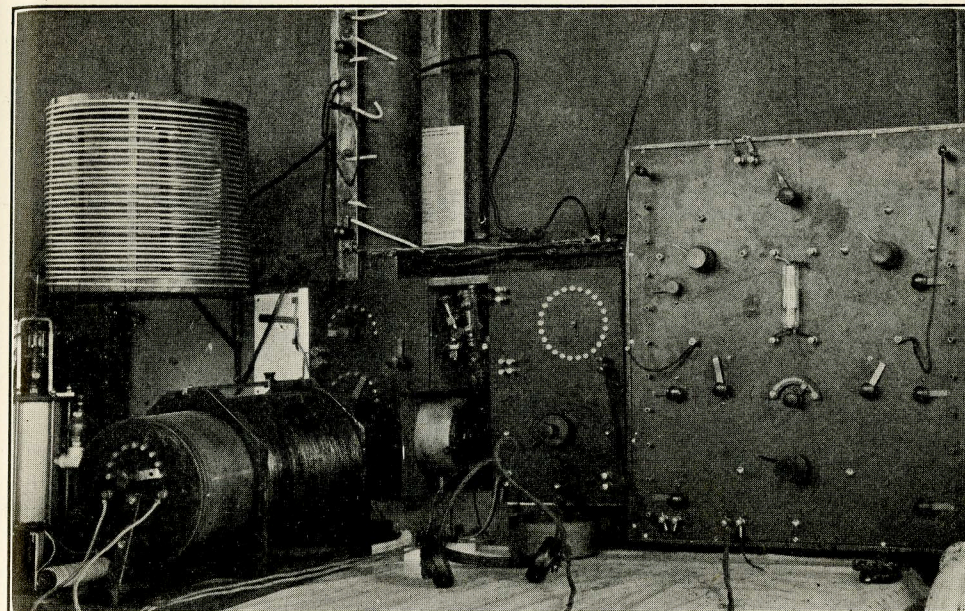

*Louis Falconi's station at Fort Stanton, New Mexico*

On this page is shown a photograph of the receiving apparatus and experimental undamped arc transmitter of Louis Falconi at Fort Stanton, New Mexico. The receiving apparatus is the regular type of Armstrong circuit and has given good results despite the unfavorable conditions of the surrounding country which is extremely mountainous. German stations can be heard during the daytime and NAA has been read forty feet from the phones with no other apparatus except that shown in the photograph. The undamped transmitter is designed for experiments in wireless telephony and radiates about forty watts.

The recently-elected president, vice-president, secretary and treasurer of the Fort Wayne (Ind.) Radio Association re respectively Messrs. Carter, Paruin,

De Witt W. May and Hall. Correspondence and exchange of ideas with other clubs will be welcomed. The address of Secretary May is 3021 Hoagland Avenue, Fort Wayne.

Frank A. Caswell of 21 DeKalb Street, Dayton, Ohio, is ambitious to have the Efficiency Radio Club of Dayton continue its activities. He would also like to get in touch with those interested in the formation of a signal corps.

Kenneth Husson, a wireless amateur, accidentally shot and killed himself with a pistol on January 23 at his home in Hollis Court Boulevard, Borough of Queens, New York City. He was sixteen years old.

Members of the Albany (N. Y.) Radio Club recently listened to an address by Ensign Philip F. Hambsch on the plan of the Navy Department to enroll amateur wireless operators as a reserve corps for use in war.

Ernest Ruhlman, secretary of the Peninsula Radio Club, delivered an address to the members of that organization at a meeting held recently in the Bayonne (N. J.) Y. M. C. A., Meetings of the Club will be held every Monday evening.

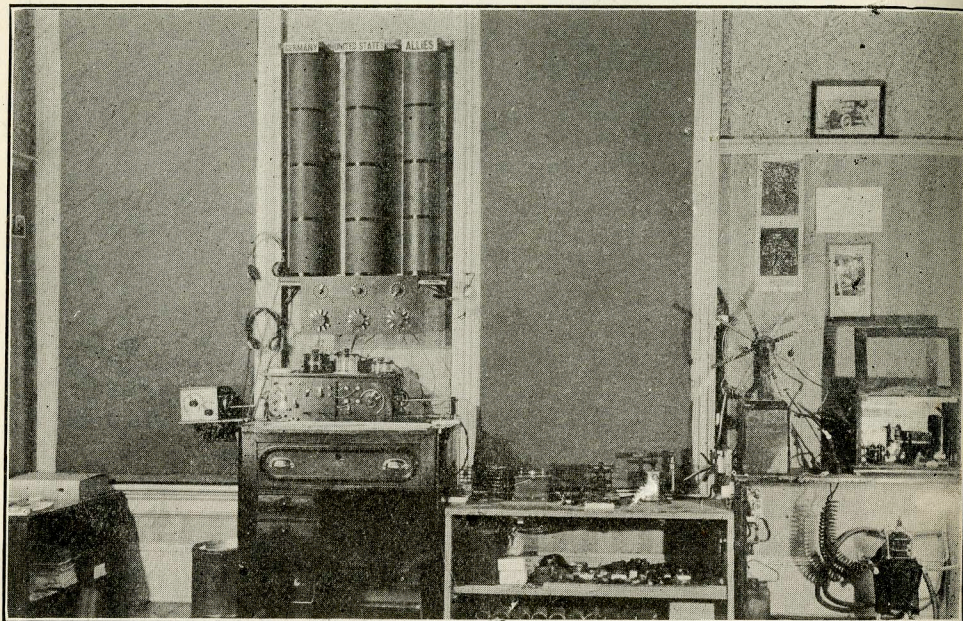

*Kent brothers' station at De Witt, Iowa*

The Clarke County Radio Association has been organized in Vancouver, Wash. It has three divisions of membership: full members who are able to receive messages in the continental code at the rate of five words a minute; honorary members able to receive twelve words a minute, and students. The officers of the Association are:

President, J. O. Dawson; secretary and treasurer, John Hertz; chief operator, Louis R. Devine.

The twenty-eighth meeting of the Radio Club of Marlboro, Mass., was

held recently. After a general discussion of radio telegraphy a few laws were passed, one, that meetings should begin at half past seven o'clock in the evening instead of at eight, and another that in the future general discussion of radio telegraphy should not exceed one hour.

Amateurs on Cape Cod have formed the Cape Cod Wireless Club, its headquarters at present being located at the home of William Chapman at Dennis Port, Mass. The Club is desirous of getting in communication with other

amateur organizations. Letters should be addressed to William Chapman at 14 Follen Street, Boston, Mass.

The Terre Haute (Ind.) Radio Club is a new organization of wireless amateurs.

A movement is on foot to organize a wireless club among the amateurs of New York City living in the vicinity of East Eighteenth Street. J. Schanz, Jr., of 230 East Eighteenth Street is one of those interested in the proposed organization.

The Lowell (Mass.) Radio Club was organized on January 6 at a meeting held at the home of Everett Taylor, 156 Winthrop Avenue. The following officers were elected:

President, Everett E. Taylor; vice-president, Wilder A. Fernald; secretary, William H. Carney; treasurer, Caleb F. Rogers. Charles H. McMasters, David H. Hanson, Warren R. Entwistle, Elmer A. Scott and Franklin S. Coppen were elected associate directors. Correspondence with other clubs is invited. It should be addressed to the Lowell Radio Club, Lowell, Mass.

Ames, Ia., has a radio club. The officers are:

President, Hollis K. Sels; vice-president, Professor C. A. Wright; secretary and treasurer, Ralph Blakeslee.

At a regular monthly meeting of the Puget Sound Wireless Association held in the Y. M. C. A. at Seattle, the following officers were elected:

President, Vincent I. Kraft; vice-president, O. S. Van Olinda; treasurer, Charles E. Williams; secretary, Ernest F. Goodner. The "Measurement of

Capacities" was the title of a paper presented by Philip D. Naugle.

The New Haven (Conn.) Radio Association has elected the following officers:

President, W. F. C. Hertz; vice-president, R. Merwin; secretary, R. H. Campbell; treasurer, A. P. Seeley. The Club meets every Tuesday evening in its home in the Y. M. C. A. building. Communications should be addressed to the secretary at 365 Edgewood Avenue, New Haven.

Several interesting talks interspersed with musical selections, made up an enjoyable program at a banquet held by the Louisville (Ky.) Radio Club at the Tyler Hotel.

Thirty members of the Club, which was formed less than a year ago, attended the banquet and voted to make it an annual event hereafter.

The principal address was made by Professor Warwick M. Anderson, of the University of Louisville, whose subject was "Wireless Observations Made on the Civilian Naval Cruise Last Summer."

#### READY TO TEST HAMMOND TORPEDO

John Hays Hammond, Jr., has announced that he will turn over to the Government his wireless controlled torpedo whenever the Government shall desire it.

Last August a board of officers, consisting of Major General Leonard Wood, of the army; Captain John A. Hoogewerff and Commander David W. Todd, of the navy; Lieutenant Colonel George O. Squier, signal corps; Lieutenant Joseph V. Ogan, of the navy, and Captain Fulton Q. C. Gardner, coast artillery corps, was appointed for the purpose of witnessing and reporting upon certain demonstrations and tests of the torpedo.

The first meeting of the board was held recently when it was decided to advise Mr. Hammond that the board was ready to observe what he had to demonstrate. The aviation authorities of the

army have been co-operating with Mr. Hammond in obtaining a suitable and properly equipped airplane for use in connection with the demonstrations.

#### HIGH-POWER STATION ASKED FOR PORTO RICO

Secretary Daniels has asked Congress for an appropriation for a high-power wireless station in Porto Rico. Mr. Daniels said the island is of "extreme strategic importance in connection with fleet operations, owing to its location, and with a protected high-power wireless station, communication would be insured with the fleet, with Europe and South America to a greater degree than by any other means."

# Faults of Amateurs and Suggestions for Improvements

By W. A. PARKS

JUST as the ambitious amateur is constantly striving to improve his apparatus in order that he may obtain better results, so should he strive to acquire more skill in operating. By this I do not mean simply the ability to send and receive rapidly, and with proper formation of the characters of the code; that is important, but it is by no means all-consequential.

A few words regarding the consideration that amateurs should accord one another deserve a place here, it seems to me. If two operators exchanging their nightly "How are you?" and "How is my spark?" are interrupted by someone who really has something to say, they should stand by until he has finished instead of harboring resentment.

Much interference is frequently due to the waste of time in sending long calls for some amateur perhaps two blocks distant from the station transmitting. One call is sufficient in such cases. Added to this waste of time is the ridiculous practice of making 5 ————'s, 10 r r r's and 15 k's during each part of the message. Display of this fault is unmistakable proof that an unskilled operator is at the key.

Many amateurs are also accustomed to holding down their keys for minutes at a time and neglecting to listen in to find out if anyone is qrw. There are few of us, indeed, who cannot find time to tune our sets either in the morning or afternoon, when we will cause no qrm with other amateurs.

Too much speed is worse than draggy sending. Never send more than twenty or twenty-five words a minute

unless you have confidence in your ability, and that of the receiving operator to handle messages at that speed.

This article would not be complete unless I directed attention to the practice of calling a station as soon as it is heard, although the operator at the station in question has just called someone else. This practice is impolite to say the least. Another example of what not to do along the same lines is the habit of calling without first listening in to find out if anyone is working.

When abbreviations are employed the qr's qs's should be used in all cases. There are other abbreviations in general use among amateurs. Many of these are from the Phillips Code. Some follow:

abt, bi, clr, cud, cul, ga, gb, gg, gm, gn, gv, hr, hw, min, msg, nw, pwr, r, rt, sed, ses, sigs, spk, tks, tmw, tnx, tt, u, ur, wd-s, wr, wt.

It should be understood that the writer makes no claim to being an infallible authority on the subject discussed in this article. He has, however, been an amateur for several years and has had opportunity to observe considerable transmitting and receiving. It is on this experience that he bases his statements and suggestions.

## MEDAL FOR PROFESSOR PUPIN

At the fourth annual convention and dinner of the National Institute of Social Science held in New York City, a medal was awarded to Professor Michael I. Pupin for his work in wireless telegraphy and the long distance telephone system.

# The War's Wireless Record

NO sooner did the crisis between this country and Germany occur, than the United States Government at once took possession of the Sayville wireless plant at Sayville, L. I., which is controlled by German interests. On orders telephoned from Washington on February 4th, Lieutenant D. S. Lindsay, U.S.N., commanding the detachment of marines and bluejackets in charge of the station, discharged from employment twelve Germans who have been at work there since the Navy Department assumed control of the station.

On the night of the same day four wireless operators went on duty at police headquarters—probably to remain there indefinitely. With its wireless apparatus, the Police Department will keep in constant touch with naval and army stations.

Rear Admiral William S. Benson, Chief of the Bureau of Operations in Washington, the next day sent by cable and wireless to all American naval commanders a specific set of instructions covering the actions they are to take in difficult situations. The exigencies specified and the action to be taken in each case were contained in confidential code messages.

Wireless messages sent out on February 7th, by the Standard Oil Company of New Jersey, recalled such of its vessels as would have to pass through the "barred zone" established by Germany in order to reach their destinations. As a result the tankships *Communipaw* and *Pioneer* put back to the port of New York. The company has a fleet of about forty ships, twelve of which are in the Atlantic service, and others are expected to return to their ports in obedience to the wireless orders.

The presence of German raiders in

the North Atlantic caused considerable anxiety to the skippers of trans-Atlantic liners and freighters. Passengers arriving on the French liner *Espagne*, on January 4th, from Bordeaux, told of seeing a ship corresponding to the raider's description in the Bay of Biscay, while incoming travellers on the *Tuscania*, of the Anchor Line, told of making a wide detour south to avoid regular shipping lanes.

Ten days later Captain Bullen brought the British steamer *Herschel* into Boston from Cardiff, Wales, having safely traversed the German submarine zone off the Irish coast. Warnings of the presence of submarines in the trans-Atlantic steamer lane reached Captain Bullen at Cardiff, and he fitted up a dummy wooden cannon, fashioned from a spar and equipped with smoke bombs and detonating caps. Upon receiving additional radio warnings after sailing, Captain Bullen ordered the after deck cleared for action, and the "gun" was mounted and manned, to convey the impression that the crew was engaged in target practice, and thus frighten off U-boats.

About a week afterward fast cruisers of the Allies in the Atlantic threw out an immense net for a German raider, then believed to be the *Moewe* or a sister ship, which sank or captured a score of allied and neutral merchantmen between December 12th and January 10 in the Atlantic. Reports from Norfolk said that wireless messages picked up from ships indicated that the commerce destroyer, after her exploits in southern waters, was headed north, obviously to operate in the more frequented trans-Atlantic shipping lanes. She was then thought to be about 1,500 miles south of Cape Henry, according to the wireless talk of British captains on the Atlantic.



# Some Recommendations for Improved Amateur Legislation

By 9XE

National Chief of Relay Communications  
NATIONAL AMATEUR WIRELESS ASSOCIATION

AFTER a thorough study of the bill to regulate wireless communication, which was approved by Congress August 13, 1912, I have set down on paper the suggestions and ideas regarding legislation for amateurs contained in this article. The remedy for improving conditions, I believe, lies in the utilization of my arguments to present the subject in its true light with the object of obtaining sufficient support to introduce into the legislature of each state a bill to control its amateur stations.

It is provided in the Constitution of the United States that Congress shall have power to regulate commerce with foreign nations and among the several states, and with the Indian tribes. Relaying for pleasure or glory is certainly not commerce in any sense of the word. Why should any restrictions be placed on the operation of an amateur station with the exception of a license, wave-length and QRM penalty? An inspection of an amateur station is surely not up to the United States Government, it is a state right and the only condition of obtaining a license from the Government should be that the operator is an American, and that no wave-length greater than 200 meters be used. The discussion about decrement is useless, so far as amateur stations are concerned. The grading of licenses by the Government is usurpation of the state right and nothing should be needed from the Government other than a permit to operate an amateur station.

I concede the right of Congress to license and tax, if necessary, but I cannot escape the conclusion that a mistake has been made in regulating the use of amateur stations. An amateur wireless station is looked upon as a means of edu-

cation, or amusement, as the case may be and even if its signals are heard in another state, no regulation by Congress is needed.

I suggest that a Government License should, in no circumstances, be granted until the conditions of the state are first met. Few, if any, amateur stations are inspected by the state electrical inspectors. Why? Because the states have not been educated up to the fact that their jurisdiction covers the inspection and proper operation of that station. The Government issues a license to saloons, but does not attempt to control them, because this power belongs to the state. Congress admits it has no authority over a wireless message between points in the same state. I contend that it should have no authority over any amateur wireless message sent to any state.

The amateur should strive for a proper state regulation as to hours of transmission for clubs engaged in more serious work, a division of time for spark coil operators without licenses and a special time for sending for individuals who are not engaged in any particular work, but are merely amusing themselves. They should aim also for a curtailment of the privileges extended to amateurs who send sporting news and crop conditions without exercise of good judgment.

The practical way to better conditions is to have one bill prepared and present a copy of it to all the legislatures of the various states. By appointing one captain of the QRM League in each state of the Union, who will appoint three lieutenants, each of whom will appoint five helpers the movement has been started. These helpers will gather the opin-

ions from their neighborhood, forward them to their respective lieutenants, who, in turn, will condense these opinions and forward them to their captain, he, in turn will either O. K. or change them and forward them to the zone manager for that territory. There will be as many zone managers as there are radio inspection divisions.

By this means it will be possible to get the best opinions from the leading amateurs of the country, condense them and arrive at a working basis for the framing of a bill to be presented to the legislatures of the various states. Many of the states are already organized. Another thing, we want to have your opinion concerning, is about State Inspection of Amateur Stations.

The Q. R. M. League would also like to obtain the opinion of amateurs re-

garding state inspection of amateur stations. It would be best to have all stations wired properly and with due regard to life and property. The electrical world would never have made the progress it has if there had not been some regulation about wiring. Send your comments to the helper of the Q. R. M. League in your district, whose name will be published shortly in this magazine.

In the relays that have been conducted under the supervision of the writer, the governors and mayors of the various states were first made figures in the events. Then the nominated president was brought into relay and it was demonstrated to President Wilson what could be done in the way of getting signatures to a M. S. G. The amateurs should use the same amount of energy in seeking improved legislation.

## New Aeroplane Receiving Set

Dr. R. O. Shelton, of San Diego, Cal., sends in an interesting description of a receiving set constructed by him, with various devices of his own, which he has been using in the wireless aeroplane experiments that are being conducted by him and Captain Culver. His letter is in part as follows:

"In your November issue of THE WIRELESS AGE, under the heading of 'New record for aeroplane transmission' you have reported some of the experiments which Capt. Culver and myself have been conducting for some time. The last flight was made last week, and I was able to read him in the machine at a distance of 140 miles, when an oil lead on the machine was broken, forcing them to return to Martin field at Los Angeles for repairs.

"It might be of interest to you to know the aeroplane was equipped with a 1/4-k.w. army field set, 60 ft. aerial on the upper plane and a 300-ft. trailing counterpoise. The aerial circuit had to further be loaded, besides the oscillation transformer to get a little over 200 meter wave. A much longer aerial is

required to get the wave with no ground.

"The receiving set was constructed by myself and consists of aerial 120 ft. long, 75 ft. high, lead-in and ground 130 ft. with series condenser; small receiving transformer; amplifying phones; two step audion. The hook-up in the audions is of my own device, and gives better results than the best Armstrong. It is simple, easily tuned, requires only a grid loading coil, and, contrary to the Armstrong hook-up, works as good on the 200-meter wave as on higher ones. It tunes arc or spark with no change in the circuit other than tuning. I am perfecting the hook-up and when finished will give it out to the amateurs in general. I am able with the above set to read the German stations. Other stations in proportion. Common occurrence to hear 6-SH at Stockton, Cal., and talk with 6-AJC at Long Beach—90 miles distant—who uses a small coil and a 6-60 storage battery for power. I have heard over 100 stations north of here from 90 to over 500 miles. And all with the QRM of NPL which is less than 5 miles distant."

## New York Signal Corps in the Field

*What Company A, the Wireless Section, Achieved on the Texas Border*



*Photo. by C. H. Johnson*

*New York's crack wireless company on the march*

THE First Battalion, Signal Corps, of New York, during its recent stay on the Texas border over a period of more than five months with the New York Division, won a splendid record for itself. In the words of Major William H. Hallahan, the battalion's commander, the men of his outfit were the most fit of any of the National Guard commands that went to the border. "Every man made good," said the Major. "We were ready to go ahead with our work the minute we reached McAllen, and the manner in which we handled the communications for the regular army as well as for the various State divisions won praise from the army officers. We ran telephone lines to the most distant outposts, and made our wireless outfits, good ordinarily for thirty-mile radius, communicate with Fort Sam Houston, 240 miles distant."

Public comment was made on the fact that the Signal Corps was the first organization to return from the border without voicing complaints of having been held there too long and without circulating stories of having experienced unnecessary hardships. The men returned in the best of physical condition and almost to a man agreed that their experience on the border had been both pleasant and profitable.

As a matter of fact, the men had no time to become discontented. During the five months they were in Texas, they erected more than 500 miles of telephone and telegraph wires, besides establishing several radio stations. They patrolled along a line of practically seventy-five miles, and did it as efficiently as a regular army organization could possibly have done it.

The radio company of the battalion it is understood, carried off most of the honors of the occasion. The crack wireless section of the Signal Corps is Company A, of which Captain Robert W. Maloney is in command. Captain Maloney has given an entertaining account of the experiences that beset the wireless men of the Signal Corps on their arrival at the Texas border, the difficulties with their equipment, the improvements they instituted and how achievement triumphed over the handicaps of unfavorable weather and obsolete wireless outfits. The  $\frac{1}{8}$ -k.w. set with which the Signal Corps of the National Guard was provided was found unsuitable for the work that was to be done, it having insufficient power to work for the distances that had to be covered, but as rapidly as possible the men of the Signal Corps were provided with the far superior 1915 pack set in use by the regular Army.

*Captain Robert W. Maloney's Account of the Experiences of His Command*

"The Army," said Captain Maloney, "has its regular system of 5 and 10-k.w. stations running across the country, at Fort Sam Houston and various other Army posts. These are permanent stations and not stations that can be taken around in military operations. The regular Army troops are provided with the 1915  $\frac{1}{4}$ -k.w. inclosed gear type generator and the new 1915 pack set, loaded on pack mules. They are equipped with 45-foot masts, a hollow spar mast, jointed like a fishing pole. In addition the regular Army has a 1-k.w. wagon set and a 2-k.w. auto tractor set.

"The National Guard's wireless equipment was to a large extent obsolete when we went to the border. It had no wagon or tractor sets and our company and others were equipped with old style  $\frac{1}{8}$ -k.w. 500 cycle 1912 sets, with exposed gears. This was in general the equipment. We got down to the border in July and found ourselves in the midst of a stormy and rainy season. Our experiences showed that the  $\frac{1}{8}$ -k.w. set was

practically worthless, so far as possessing sufficient power to work for any distance or overcome any slight static. The receiving set was not very serviceable. But as rapidly as the Government could get them out, we were provided with the 1915 sets and by the time of our return, we were equipped with four of the 1915 pack sets. This is really a most remarkable set. The generator is entirely inclosed in an aluminum case and the gears run in oil. This is a great

advantage as it prevents the alkali dust from running into the gears, as happened with the old 1912 set. With the latter we were lucky to obtain  $1\frac{1}{4}$  amperes, while with the new set, with the same amount of muscular exertion, we could run it up to  $2\frac{2}{3}$  or 3 amperes. The receiving set was also far superior to that of the 1912 outfit. It has an oscillation transformer with a triple folding helix and the tuning coils are much larger and get a far greater range. It is also equipped with the new Baldwin 'phones and a silicon detector.

"We found down there that the ordinary radio mast, 45 feet in height, was too short to enable us to get good results. In order to send any great distances, we were obliged to increase the height to about 70 feet, using extra sections of mast. The antenna consisted of four loosely braided bronze wire strands, each consisting of three wires. These were subdivided for the purpose of creating an umbrella type of aerial into twelve single strands. We also doubled the counterpoise by using two counterpoises

hooked together. As a result of these changes we found that the receiving qualities of the set were wonderfully increased as well as the sending power.

"With this little  $\frac{1}{4}$ -k.w. set the New York Signal Corps from September until the end of December handled all of the Government business between San Antonio and McAllen, Texas, which came through for the Sixth Division (New York). In other words, this little  $\frac{1}{4}$ -k.w. working with a 10-k.w. set at Fort

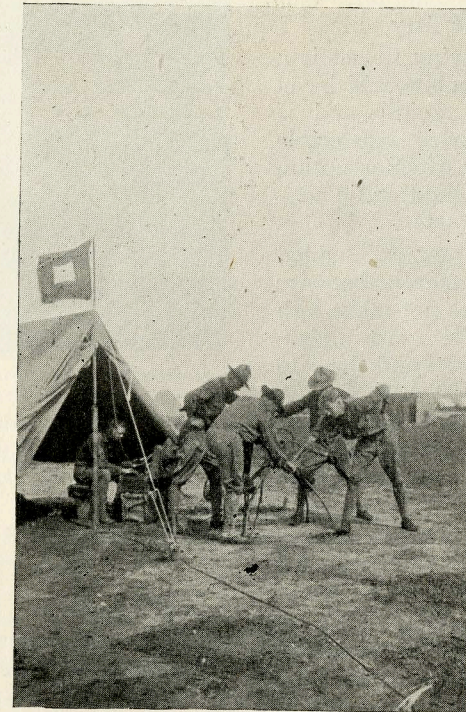

*Photo. by C. H. Johnson.*

*Field wireless station in operation, with power for transmission of messages being supplied by hand generator*

Sam Houston, handled all the business over a distance of nearly 300 miles. Not only was official business handled, but time signals were all taken from Washington, the regular press reports received from Key West and the daily press bulletins published. The World Series was reported and on Election night, receiving the returns by radio from Fort Sam Houston, we were able to beat the commercial wire telegraph by several hours. In ordinary quick field work we had no trouble at all, making communications over distances of forty to fifty miles.

"What the Army is trying to get is a light weight set, highly mobile, which can be assembled and set up rapidly, and of a sufficient power to cover reasonable distances without danger of interruption or interference either by light static conditions or by other light sets.

"It might be well to remark," added Captain Maloney, "that merely because a man is an operator, does not make him a Signal Corps man. He must understand horses and mules, and has to know how to pack an A P A R A J O. He must understand visual signalling and should know lineman work. During our presence at the border we built three complete camp telephone systems with about 30,000 feet of twisted wire each and rebuilt about 100 miles of telegraph lines, besides erecting buildings to put our central stations, etc., in."

One of the detachments of the battalion had an amusing experience, during which it displayed its resourcefulness by sending messages over a barbed wire fence. The detachment was stationed near Hidalgo, and was furnishing information to an infantry regiment which was operating several miles up the Rio Grande. A patrol of the opposing force discovered the lines and cut them, and then stationed a guard to see that they were not repaired. When the men of the detachment found out what had occurred, they connected up with one of the wires of a barbed wire fence, and the detachment on the other side did the same thing. In this fashion they managed to get their messages through with very little interruption.



Photo. by C. H. Johnson.

*Portable equipment being transported in field, showing method of carrying mast sections and apparatus*

### EXAMINATIONS FOR RADIO OPERATORS

It is announced by L. R. Krumm, Chief Radio Inspector for the Radio Service of the Department of Commerce, that the examination of applicants for radio operators' licenses will be discontinued at the Brooklyn Navy Yard and Fort Wood, Bedloe's Island, until further notice.

Beginning February 12th, examinations for operators will be held in the office of the Chief Radio Inspector, No. 603 Custom House, New York City, every day at 10:00 A. M., to 2:00 P. M., except Saturdays, Sundays, and holidays.

All necessary forms will be furnished and filled out at the time of the examination. The papers will be marked and licenses issued as soon after the examination as possible.

## Queries Answered

Answers will be given in this department to questions of subscribers, covering the full range of wireless subjects, but only those which relate to the technical phases of the art and which are of general interest to readers will be published here. The subscriber's name and address must be given in all letters and only one side of the paper written on; where diagrams are necessary they must be on a separate sheet and drawn with India ink. Not more than five questions of one reader can be answered in the same issue. To receive attention these rules must be rigidly observed.

### Positively no Questions Answered by Mail.

B. R., Casey, Iowa, inquires:

Ques.—(1) I purchased a 10-inch Marconi induction coil of the type used aboard ship. What size spark should be obtained with a condenser capacity of .0125 microfarad?

Ans.—(1) This value of capacity is excessive for these coils. A condenser of .004 or .005 microfarad is of the correct value and should give a spark discharge of about  $\frac{3}{4}$  of an inch in length.

Ques.—(2) What is the approximate capacity of each section of a Murdock moulded condenser?

Ans.—(2) Each section has a capacity of about .0017 microfarad. Three of these connected in parallel would do for the 10-inch Marconi coil, but if you want a series parallel connection you will require twelve sections. Six sections should be connected in parallel in each bank and the two banks finally connected in series.

It should not be necessary to publish a diagram in THE WIRELESS AGE for the connections of this apparatus, as previous issues have contained many diagrams applicable to your equipment. The book "How to Conduct a Radio Club" also contains a number of diagrams and advice for the beginning amateur.

\* \* \*

R. J. F., Southampton, N. Y.:

If the steel mast you propose to erect is to be supported by guys, you can insulate it at the base by building up a wooden platform which in turn rests on a set of glass insulators. While glass will not stand a hard blow, it has considerable pressing strain and will serve your purposes. The base of the mast may be housed in to protect it from dampness and consequent leakage. We advise you to purchase a copy of the book "How to Conduct a Radio Club" and find out for yourself how to tune a wireless telegraph station.

By referring to the curves in the November, 1916, issue of THE WIRELESS AGE you can easily determine whether or not the wave-length of your antenna is within the Government requirements; otherwise you will require a wavemeter by which the wave-lengths radiated from your station can be definitely measured.

Your 500-foot aerial has an approximate wave-length of 800 meters.

\* \* \*

J. B., New Orleans, La.:

You should construct your filament rheostat of No. 20 or No. 22 German silver wire. Purchase enough to give a maximum resistance of about 20 ohms.

We do not understand what is referred to when you speak of the rheostat for the grid circuit.

\* \* \*

G. C. W., Lexington, Conn.:

An exposed telephone wire gives fair results as a wireless telegraph aerial, depending to a large extent upon the local conditions and the general location of your station. The antenna posts of the receiving set should be connected through a variable condenser to one side of the telephone line. Care should be taken to select that side of the line which is not already grounded through a 2 microfarad condenser. Good results should then be obtained, particularly from stations near by. Whether or not you will be able to hear stations on the Atlantic coast is problematical.

\* \* \*

J. C. P., Chambersburg, Pa.:

You and other inquirers requiring a complete set of instructions for the construction of a closed core transformer should purchase a copy of the book entitled "Wireless Telegraph Construction for Amateurs," by Alfred P. Morgan. This can be purchased from the Book Department of this magazine. We have no information at hand concerning the windings of the Packard  $\frac{1}{2}$  k.w. transformer.

\* \* \*

A. A. K., Passadumkeag, Me.:

It is impossible for us to solve your problem without being on the ground, but we advise you to thoroughly test all circuits of your receiving apparatus for an open circuit. The parallel telegraph and telephone wires without doubt shield your station and absorb a certain amount of energy in the passing waves, but the fact that you once heard stations and now do not indicates that something must have happened to your apparatus.

A. B. L., Helena, Mont.:  
 Figure 19b on page 861 of the September, 1916, issue of THE WIRELESS AGE gives a detailed connection of the vacuum valve amplifier where one storage battery is used to light two filaments. The potentiometer control for the local batteries, B2, of the vacuum valve is shown in Figure 18 on page 860. This is nothing more than a 3,000 ohm potentiometer shunted around the high potential battery. It allows a very close regulation of the local voltage in the usual manner. We have no preference in the matter; in fact we should be perfectly satisfied to vary the voltage of this battery by means of a multipoint switch.

\* \* \*

R. O. P., Scottville, Mich.:  
 The receiving tuner you have described is responsive to wave-lengths inclusive of 3,500 meters and you will therefore not be able to receive signals from undamped wave stations which usually operate at waves in excess of 6,000 meters. Practically any receiving tuner that will adjust to waves up to 6,000 meters will be useful in connection with the tikker detector.

\* \* \*

V. C. D., Issaquah, Wash.:  
 No. 32 single silk covered wire or single cotton covered wire will do for the secondary winding of the transformer in question. This wire should be soaked in hot paraffine before being wound on the secondary pies.

(Continued on page 442)

H. W. X., Chicago, Ill., inquires:  
 Ques.—(1) How far should one be enabled to copy signals from the Arlington station with a first-class receiving tuner of inductively coupled type connected to a single vacuum valve detector?

Ans.—(1) No difficulty should be experienced in taking down these signals during the night schedule at a distance of 2,500 miles throughout the favorable months of the year.

\* \* \*

E. R. H., Middletown, Conn., inquires:  
 Ques.—(1) Referring to the wavemeters described in the book "How to Conduct a Radio Club," is it possible to substitute a cardboard tube for the hard rubber tube upon which the coil of inductance is wound?

Ans.—(1) The cardboard tube may be substituted with a slight change in wave-length.

Ques.—(2) Are the plates for the high voltage storage battery referred to in the First Prize article in the October, 1916, issue of THE WIRELESS AGE made of plain lead or are they coated with that material?

Ans.—(2) They are made of plain lead.

Ques.—(3) How can bakelite or hard rubber be polished?

Ans.—(3) By an ordinary buffing wheel.

\* \* \*

O. A., Conava, Ala.:  
 Ordinarily a one- or two-inch spark coil will easily permit communication with another station eight miles distant.

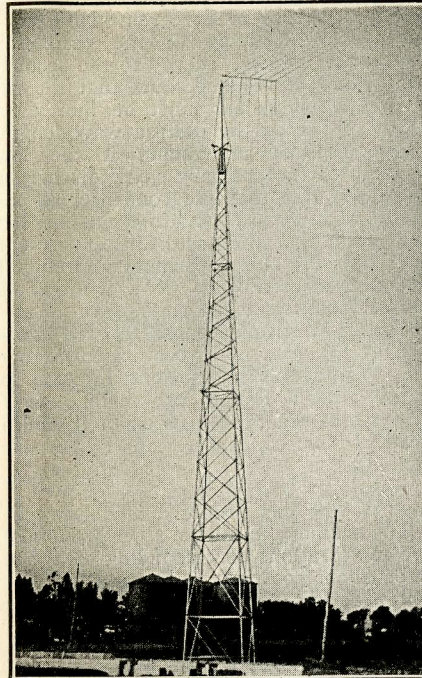

Station at Fort Monroe, Virginia

## STEEL TOWERS GALVANIZED or PAINTED

*of any desired height, of first class construction and at extremely low prices.*

*The self-supporting type does away with guys entirely and those of moderate height do not require expensive concrete footings.*

### MILLIKEN BROTHERS INCORPORATED

NEW YORK, 111 BROADWAY

London - San Francisco - Buenos Aires

Hydro-Electric Transmission Engineers  
 Manufacturers of all Classes of  
 Structural Steel Work.

# WANTED! — 100 — LICENSED RADIO OPERATORS

FOR THE MARCONI SERVICE

ADVANCED AMATEURS, COMMERCIAL WIRE OPERATORS, and others possessing FIRST OR SECOND GRADE COMMERCIAL LICENSE CERTIFICATES are invited to send in their applications at once.

## Immediate Positions Assured

Elementary class now forming. Good Pay. Pleasant Travel. Congenial Surroundings. Day and Evening Classes Throughout the Year,

**TUITION FREE FOR DAY OR EVENING SESSIONS**

Receive your training on Marconi apparatus, in a company owned school under Marconi supervision.

Call 'Phone or Write.

**INSTRUCTING ENGINEER**

EDISON BUILDING, 25 ELM STREET

NEW YORK CITY

Send for illustrated prospectus.

When writing to Advertisers please mention THE WIRELESS AGE

## Public Utilities Bought and Sold

Investigation and Engineering Reports Furnished

We are interested in and can furnish information concerning the following Companies:—

- Long Island Lighting Company
- Suffolk Gas & Electric Light Co.
- Suffolk Light, Heat & Power Co.
- Huntington Light & Power Co.
- North Shore Electric Light & Power Co.
- Perry Electric Light Co.
- Sag Harbor Electric Light & Power Co.
- Long Island Gas Corporation
- South Shore Gas Co.
- Consumers Gas Co. of Long Island
- Warsaw Gas & Electric Co.
- Northport Water Works Co.

Consult us before installing Wireless Stations.

## E. L. PHILLIPS & CO.

ENGINEERS

50 Church St., N. Y. C.

## ELECTRICAL HANDY BOOK AND CATALOGUE FREE



WORTH 25 CENTS TO ANYBODY  
 The BIG BOOK you need and want. Describing positively the finest and most complete line of wireless, novelty, and experimental goods ever listed in any catalog and containing besides, innumerable tables, book-ups and treatises of inestimable value to the experimenter. Absolutely Free. Send No Postage.  
 THE ELECTRO-SET COMPANY  
 Leader Building, Dept. WA-10 Cleveland, Ohio

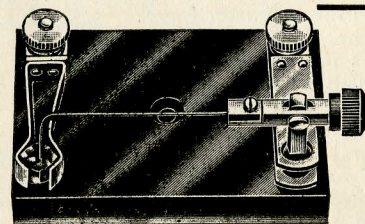

THE Jovo Crystal Holder is the handiest and most perfect yet produced. Holds crystals without screws. Has double posts for condenser and phones. Firmly holds crystals of different minerals at same time. Change of contact from one to the other instantly made; a sensitive point quickly found, and correct pressure held constantly without using a single screw or nut. Designed and finished in our high grade style. Mounted on dark enameled porcelain, metal parts nickel-plated, and highly polished.

Postage weight 1 lb.

Price, Net, \$1.25

Send stamp for our Wireless Catalog No. 368 with "Premium Offer"

## J. H. BUNNELL & CO.

32 Park Place

NEW YORK

When writing to Advertisers please mention THE WIRELESS AGE

J. F. M., Marlboro, N. J.:

Practically all the data you require will be found in the curves published in the September, 1916, issue of THE WIRELESS AGE, pages 108 and 109. Careful observation of these wave-length curves by all amateurs is recommended.

\* \* \*

P. E. N., Fort Smith, Ark.:

The aerial you have described is suitable for transmission at a wave-length of 200 meters.

Stranded iron cable is not considered a good conductor for the earth connection of a wireless telegraph set; copper cable is by all means preferred. Of course a great number of strands of galvanized iron wire would probably have sufficient conductivity, but the copper cable would give the best results in any case.

The dimensions for a rotary gap can vary considerably and still effect the desired purpose. A good design is to make a disc 8 inches or 10 inches in diameter and mount thereon eight or ten electrodes, equally spaced about the circumference. This disc should rotate at speeds varying between 2,400 and 3,000 revolutions per minute.

\* \* \*

J. F. N., Norfolk, Va., inquires:

Ques.—(1) At present I use an aerial 600 feet in length made of two wires separated 6 feet. Would it be practical to cut off one end of the flat top with insulators for use on wave-lengths around 200 meters, the lead-ins being taken from either side of the insulators? The small aerial is to be used for receiving and transmitting purposes in connection with a 1 k.w. set, but I planned to use either the long or the small aerial or both connected together for the reception of longer wave-lengths.

Ans.—(1) The connection you propose is practical and will not interfere with the efficiency of the apparatus to a marked extent. Care should be taken to separate the lead-ins of the two antennae and not to have them lie in a close parallel position, otherwise the small aerial when transmitting may set the large aerial into oscillation and cause it to radiate a wave of another length.

Ques.—(2) Frequently I come across an expression which seems to limit the capacity of the condenser in a closed circuit .02 microfarad. Is this value of capacity a fixed quantity, or is it the usual capacity employed in connection with the 200 meter wave?

Ans.—(2) The wave-length to be radiated definitely limits the size of the condenser in the closed oscillation circuit and the maximum permissible capacity for the closed circuit of a 200 meter set is .01 microfarad as has been mentioned several times in the columns of this department. Two k.w. transmitters of the 60 cycle type frequently use values of .02 microfarad, but when a transmitting set is designed to operate on the three standard wave-lengths of 300, 450 and 600 meters, the capacity should not exceed .012 microfarad. To illustrate, the 2 k.w. standard panel sets of the Marconi Company use a capacity of .012 microfarad

for the 450 and 600 meter wave, but a value of .006 microfarad for the 300 meter wave. Since it is necessary to have some inductance in the primary winding of the oscillation transformer to transfer energy to the secondary, you will readily understand that the capacity of the condenser must be limited in order not to exceed the desired wave-length.

Ques.—(3) As I understand it the low pitched note of the ordinary spark discharger is due to the fact that the condenser is excited from a 60 cycle alternating current, but it would seem that the usual amateur rotary gap interrupts the closed oscillatory circuit at least 300 times per second. Now it might be possible to construct a gap running in an airtight housing at such speed as to give interruptions at the rate of 10,000 or 20,000 per second. Would this be efficient for use in connection with a limited 200 meter wave? Would a gap of this kind increase or diminish the demand for condenser capacity in the closed circuit?

\* \* \*

Ans.—(3) The gap proposed is not practicable. The ordinary telephone receiver is most sensitive to vibrations corresponding to a frequency of about 500 cycle alternating current and you probably are aware that vibrations above 20,000 per second are practically inaudible to the human ear. Furthermore, you could not interrupt the closed oscillatory circuit 20,000 times per second and have useful energy at each interruption because, the frequency of the current supply being no more than 50 cycles per second, many interruptions of the spark gap would be obtained when the condenser voltage was at zero.

\* \* \*

V. S., Urbana, Ill.:

We have had no experience with the oscillating vacuum valve circuit where the antenna is connected to the plate instead of to the primary winding of the usual receiver and consequently we can give you no advice.

Practically equal results will be obtained with all kinds of receiving telephones listed in the first part of your query.

We know of no better undamped oscillation circuit than that described in the second edition of the book called "How to Conduct a Radio Club." If the apparatus listed therein is duplicated good results will be obtained up to distances of 4,000 miles.

\* \* \*

R. J. C., Fort Wayne, Ind., inquires:

Ques.—(1) Please give an approximate formula for determining the capacity of a condenser to be used in connection with a rotary spark gap, when the secondary voltage of the transformer, the frequency of the current supply and the power in watts are known. In the particular problem I desire to have solved, the transformer has an input of  $\frac{3}{4}$  k.w. with a secondary voltage of 16,000 volts operated on a 60 cycle alternating current. The speed of the motor is approximately 3,000 r. p. m.

Ans.—(1) You failed to give us the number of spark discharge electrodes on the rotary

**If you ever use  
an M-A-F you will  
always use one.**

Multi-Audi-Fone . . . . \$ 18.00

Two Step M. A. F. . . . 75.00

Un-Damped Waver . . . 100.00

M. A. F. Detector Stand 4.25

Detectorfone . . . . . 35.00

*Send for Circular*

**MULTI-AUDI-FONE**

271 Morris Avenue  
ELIZABETH, N. J.

**DO YOU READ THE  
WIRELESS WORLD?**

In it you will find articles relating to the PRACTICE of Radioteleg-raphy as well as to the THEORY.

The QUESTIONS and ANSWERS SECTION is open to YOU for the SOLUTION OF YOUR DIFFICULTIES.

INSTRUCTIONAL ARTICLES for Home Study WRITTEN BY EXPERTS.

REVIEWS OF BOOKS useful to Wireless Students. The interests of Operators are well catered for.

WRITE for a Specimen Copy, post free to

**THE WIRELESS PRESS, Ltd.**

Marconi House, Strand, London, England

"WIRELESS WORLD," \$2.00 per annum for America  
Single Copies, 20c Post Paid

**WANTED**

**BACK NUMBERS OF  
THE WIRELESS AGE**

*for*

Dec. '14, Jan. '15, June '15, July '15, and Aug. '15

**WE WILL GIVE**

25c or a three months' additional subscription for each copy sent us which is in perfect condition

*Send to*

**WIRELESS PRESS, INC.**

42 Broad Street, NEW YORK.

disc, but assuming that you have a disc 8 inches in diameter fitted with 6 spark electrodes, at a speed of 3,000 revolutions per minute you would obtain 300 sparks per second which would be approximately the equivalent of 150 cycles with a synchronous spark set. We may use the following approximate formula:

$$C = \frac{W}{V^2 N}$$

where C = the capacity of the condenser in microfarads

V = secondary voltage of the transformer in (kilovolts)

N = the cycle frequency

W = watts consumption at secondary.

Then in your particular problem:

$$C = \frac{750}{(16)^2 \times 150} = .02 \text{ microfarad approximately.}$$

This formula requires considerable modifications under various operating conditions, but is sufficiently accurate for preliminary determination.

\* \* \*

P. E. G., Mt. Sterling, Ill.:

Your query regarding the wave-length of an aerial is fully answered in the curves published in the November, 1916, issue of THE WIRELESS AGE. In view of the fact that these curves have been presented in a recent issue, we do not consider it necessary to make extended computation of the wave-length of aerials for our readers.

An oscillation transformer must by all means be provided for a 1 k.w. transmitting set.

The wave-lengths of the various government and commercial stations are listed in the government call list which can be obtained from the Government Printing Office, Washington, D. C.

\* \* \*

E. W. M., Ridgewood, inquires:

Ques.—(1) Please publish the overall dimensions for a ¼ k.w. open core transformer.

Ans.—(1) The primary core for this transformer may be 15 inches in length, 2 inches in diameter, made up of a bundle of fine, soft, iron wire. The core should be covered with two or three layers of thin Empire cloth followed by two layers of No. 14 double cotton covered B. & S. magnet wire.

The completed primary winding should be then inserted in a hard rubber or micanite tube with walls about ⅛ of an inch thick. The secondary winding is split into about eight sections, each of which are approximately 1 inch and ⅛ inch in thickness and 6 inches outside diameter. The sections of the secondary are wound up with No. 30 B. & S. single silk covered wire. Just previous to the winding, this wire should be soaked in hot paraffine, that is to say, during the winding process, the wire should pass through a pan of melted paraffine wax.

Ques.—(2) Approximately how many amperes will this transformer draw?

Ans.—(2) From 3½ to 5 amperes.

Ques.—(3) Will a resistance or a reactance coil be required in connection with it when connected to a 110 volt 60 cycle alternating current circuit?

Ans.—(3) It can be connected directly to the power main.

Ques.—(4) Can cardboard tubes be employed in place of the hard rubber tubes for the wavemeter described in the March, 1916, edition of THE WIRELESS AGE?

Ans.—(4) Yes.

Ques.—(5) How can the wave-length of a loose coupler be measured with a wavemeter?

Ans.—(5) The complete process is told in detail in the book "How to Conduct a Radio Club." The better method for measuring the wave-length of the secondary winding is to connect all apparatus in the regular manner and then place the inductance coil of a wavemeter in inductive relation to the secondary turns. This wavemeter, excited by a high pitched buzzer, acts as a feeble transmitter of electromagnetic wave and when the wavemeter is in resonance with the receiving tuner, the maximum response is obtained in the head telephone. More detailed information is given in the book mentioned.

\* \* \*

C. B., Edinburg, Ill.:

All information you request concerning the construction of a 10,000 meter inductively coupled receiving tuner and the wave-length of a given size loose coupler, is contained in the book "How to Conduct a Radio Club." As the information asked for is given in detail in the book, you will probably find it more satisfactory to purchase a copy of this volume than to obtain brief instructions in this department.

\* \* \*

D. G. S., Wyoming, Ohio:

We do not make a practice of publishing the operating schedules of United States Naval stations. These stations are in operation at various hours throughout the day, and we are not informed concerning the actual hours of operation.

Regarding the construction of a carbondum detector: The essentials of this device have been published in previous issues of THE WIRELESS AGE, and by referring to these you should have no difficulty in building a satisfactory detector. Please understand that the construction of this detector is simplicity itself. It is only necessary to make some sort of a spring clip holder that will allow a slight pressure to be maintained on the crystal. Better results are obtained by mounting the crystal in a brass cup with Woods metal. In fact crystals mounted in this manner have, in many cases, proven more sensitive than when simply held between two metallic contact points.

A full list of licensed amateur stations appears in the latest edition of the Government

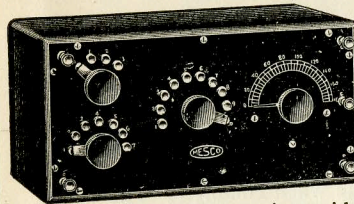

**MESCO** **SHORT WAVE REGENERATIVE RECEIVER \$32.50**

This short wave regenerative receiver is recommended for long distance relay work on wave lengths approximating 180 to 450 meters. It is possible, however, to receive wave lengths up to nearly 1,000 meters sufficiently with reduced amplification.

The circuit used is the Armstrong regenerative type with constants accurately calculated for the wave lengths referred to above when employed in conjunction with any of the audion detectors described in our Manual of Wireless Telegraphy.

With this set it is possible to receive undamped and damped waves. A blue print of connections with detailed instructions for setting up and operating this receiver is supplied with each instrument. Both tube and round type audion detectors can be used successfully with it.

Our 248 Page Pocket Catalog N 28 on request.  
Manual of Wireless Telegraphy N 9, 180 Pages, 10 cents.

**MANHATTAN ELECTRICAL SUPPLY CO., Inc.**

17 Park Place, NEW YORK    114 S. 5th Ave., CHICAGO    1106 Pine Street, ST. LOUIS    604 Mission Street, SAN FRANCISCO



**ECONOMY renewable cartridge FUSES**

are to electrical circuit protection what wireless is to ordinary telegraphy. A new Economy "Drop Out" Renewal Link, inserted in a moment, makes an Economy Fuse as good as new—at a saving over old methods of protection of as much as 80% in yearly fuse expense.

Marconi Company of America are extensive users of our fuses. To demonstrate their value we make this offer.

**Send for Bulletin 29, and list of users**

**Economy Fuse & Mfg. Co.**  
Kinzie and Orleans Streets, Chicago

**New Undamped Wave Coupler No. 749**  
**Special Introductory Price \$18.00**

32" long, 10" high and 9" wide over all. On average sized Aerial, tunes to 15,000 meters. Used with the new CHAMBERS CIRCUIT, will bring in signals from all local and long-distance Undamped Arc Stations without the use of Loading Coils, or Oscillating Coils; as they are sometimes called. Lose no time placing your order, or you will miss a great offer.

CHAMBERS CIRCUIT is entirely new, and think of it! No extra Coils to pay for, and price of Coupler only \$18.00.

Write for descriptive matter.

**F. B. CHAMBERS & CO.**  
2046 Arch St.    Phila., Pa.

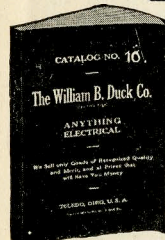

**DUCK'S BIG 300 PAGE**  
**No. 11 Electrical and Wireless Catalog**

Mailed on receipt of 8c. in stamps or coin which may be deducted on first dollar purchase. Great cost of catalog and low prices prohibit distribution otherwise.

**What This Big Catalog Contains:**  
190 pp. Wireless Apparatus; 10 pp. Raw Material; 5 pp. Transformers; 8 pp. Storage Batteries; 15 pp. Telegraph Insts.; 42 pp. Motors and Dynamos; 10 pp. Miniature Lamps; 8 pp. Flashlights; 5 pp. Massage Vibrators; 10 pp. Miniature Railways; 5 pp. Lighting Plants; 10 pp. Ammeters and Voltmeters; 25 pp. Electrical and Mechanical Books; 12 pp. Telephone Equipment; 10 pp. Auto Accessories; 13 pp. Victrolas, on Easy Payment Purchase Plan; 30 pp. General Electrical Supplies.

**THE WILLIAM B. DUCK CO., 224-228 Superior St., TOLEDO, OHIO**

**HABIRSHAW**  
*"Proven by the test of time"*  
**Insulated Wire**

Its world-wide use in every branch of industry recommends it for wireless work wherever insulated conductors are used.

14 B & S Duplex—10 B & S Lead Covered.    Aerial—Underground—Submarine.

For particulars, write

**THE HABIRSHAW ELECTRIC CABLE CO., Inc.**  
10 E. 43d St.    New York



**Super-Sensitive Microphone Only \$6**

This instrument is offered at an extremely low price. It is excellent for building your own radio amplifier. Can also be used in many experiments where a sensitive microphone is required.

**Detectagraph \$12**

This detecting instrument of marvelous sensitivity can be used for detecting secret conversations. Outfit consists of Sensitive Transmitter, 25-ft. Black Cord, Receiver, Headband, Case and Battery.

Send for One To-day and Convince Yourself

**MICROPHO-DETECTOR COMPANY,** 121-4 Nassau Street, New York  
Makers of Super-Sensitive Microphone Apparatus



When writing to Advertisers please mention THE WIRELESS AGE

Call list, copies of which can be obtained from the Government Printing Office, Washington, D. C.

\* \* \*

D. & C., Campello, Mass.:

You should have no difficulty in calculating the wave-length of the aerials described in your communication, if you will refer to the set of curves shown in the November, 1916, issue of this magazine.

Reference to the so-called "static loop" is not understood. The two aerials you have mentioned will not interfere with each other to any marked extent, particularly in receiving, although one may set up very heavy potentials in the other when transmitting.

\* \* \*

J. W., Lagrange, Indiana, inquires:

Ques.—(1) I recently purchased a 1/2 k.w. Packard transformer to operate from 110 volt, 60 cycle alternating current, but the current supply in our town is 110 volt, 133 cycles. I have been told that with this increased frequency, I can expect a greater output than that specified. Please advise if there would be any difference in the amount of power absorbed by the primary on these two frequencies. What would be the capacity required with or without a rotary spark gap?

Ans.—(1) The primary winding of your transformer will take less current at the frequency of 133 cycles than with 60 cycles. Consequently, to get the full power rating of this transformer, you must either take some of the turns off the primary winding or have a transformer specially constructed for this frequency.

Assuming that you intend to work this equipment at the wave of 200 meters length, the capacity of the condenser in the closed circuit cannot exceed .01 microfarad.

Ques.—(2) Would a cable made of nine No. 22 B. & S. wires for the secondary and 16 No. 24 B. & S. wires for the primary be satisfactory for an oscillation transformer?

Ans.—(2) The proposed windings would take care of the current, but we see no reason for going to the trouble and expense of winding a cable in this manner. Why not use No. 4 stranded rubber covered wire for the primary and No. 4 or No. 6 for the secondary winding?

Ques.—(3) How can an amateur be advised beforehand concerning wireless telephone tests, wireless relay contests, etc.?

Ans.—(3) The best way to get in touch with forthcoming tests is to become a member of the National Amateur Wireless Association.

\* \* \*

E. T. R., Brooklyn, N. Y., inquires:

Ques.—(1) I have the secondary winding for an inductively coupled receiving tuner that is 5 1/2 inches in length and 4 3/8 inches in diameter, wound with No. 26 black enamelled wire, tapped every half inch. Please inform me of the dimensions for a primary winding of the correct proportion.

Ans.—(1) The primary winding for this transformer may be 4 3/4 inches in diameter by 6 inches in length, wound with No. 24 S. S. B. Wire.

\* \* \*

J. G., Newark, N. J.:

Lacking more specific details concerning the proposed wiring of your receiving tuner, it is difficult to state the wave-length to which it will be adjustable when complete. The winding you mention, however, will require no more than 1/2 pound of No. 30 wire. No. 24 wire is preferred for the primary winding of the receiving transformer, or the aerial tuning inductance.

Data as to the wave-length of your aerial were published in the November, 1916, issue of this magazine.

\* \* \*

A. D., Utica, N. Y.:

The wave-length of your 200 foot aerial is approximately 300 meters, but since it is placed very close to the earth you may be disappointed in the results obtained when receiving. We cannot calculate the possible effect of the oscillation transformer on the wave-length of an antenna circuit unless we know thoroughly the inductance and capacity of the antenna system and the dimensions of the primary and secondary winding.

\* \* \*

F. H. H., Princeton, Ill.:

The telephone receiver used on wire telephone systems will receive wireless telegraph messages, but generally it is not as sensitive as receivers constructed specifically for wireless telegraph work. Good receiving telephones can be purchased for \$5 per pair.

\* \* \*

F. A. C., New Haven, Conn.:

For information concerning the details in wiring the diagram of a wireless telephone system, why not communicate with the manufacturers direct. If you are unable to obtain this information, it is quite likely that we will find ourselves in the same position. You are referred regarding the wave-length of your aerial to the curves in the November, 1916, issue of THE WIRELESS AGE.

\* \* \*

H. C. R., Columbus, Ohio:

If you will refer to the description of the beat receiver described in the book "How to Conduct a Radio Club" you will have an apparatus feasible for the reception of undamped oscillation.

The diagram of connections attached to your query, is appropriate for the reception of damped or undamped oscillation at short wave-lengths. Perhaps you will obtain better results by reversing the connections to the coil, L-4. In fact it is quite important that the energy from the local telephone circuit should flow through this coil in a definite direction. The lower terminal of your secondary circuit is preferably connected to the negative side of the vacuum valve filament, rather than to the positive side.



Brandes "Superior" Set \$5.50

### Buy a Brandes Head Set On Trial

TEST out Brandes Wireless Receivers against any other make. Test them for sensitiveness, clearness and distance. If within ten days you're not only satisfied but enthusiastic over them—back comes your money without a question. We can afford to give this moneyback guarantee, because we build real quality into our receivers. Take *matched tone*, for instance. The two diaphragms are toned exactly alike, strengthen the weak signals, prevent "blurring." Send 4c today for Catalog W, describing Brandes Matched Tone Receivers in detail.

C. BRANDES, Inc., Wireless Receiver Specialists, Room 818, 32 Union Square, New York.

## BRANDES

### WIRELESS HEAD SETS

The Receivers with Matched Tone

## MURDOCK RECEIVERS



2000 OHM SET \$4.00	3000 OHM SET \$5.00
---------------------	---------------------

**GUARANTEED**

to equal or surpass in SENSITIVENESS, any 'phones obtainable anywhere at DOUBLE the prices. FOURTEEN DAYS' TRIAL allowed and money back if unsatisfactory in any way. Our Catalog of wireless apparatus is FREE. Send for it today.

### WM. J. MURDOCK CO.

60 Carter St. CHelsea, MASS.  
221 Second St., San Francisco

## The "Exide" Battery for Wireless Service

The "Exide" Battery has been specially designed for wireless and emergency light-ing services.

The "Exide" Battery is the most widely used battery in the country. A majority of all electric vehicles are equipped with the "Exide" Battery, it is used in the U. S. submarines, hundreds of thousands are in service for automobile starting.

Bulletin No. 149, a copy of which can be secured from any office, illustrates and de-scribes the special design of "Exide" Battery used for wireless service.

## THE ELECTRIC STORAGE BATTERY CO., PHILADELPHIA PA.

New York	St. Louis	1888-1916	Detroit	Denver
Boston	Cleveland		Washington	San Francisco
Chicago	Atlanta	Pittsburgh	Rochester	Toronto

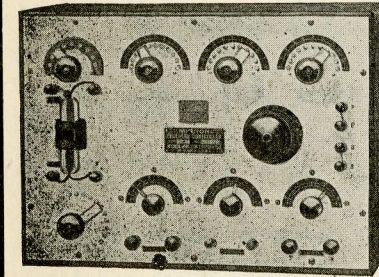

## MIGNON UNDAMPED WAVE WIRELESS APPARATUS

AMATEUR and COMMERCIAL USE

This latest Mignon invention is entering a new field in Radio Engineering, eliminating the so familiar LOOSE COUPLERS and LOADING COILS, and introduces adjustable DISC-CORES, heretofore considered impossible. DISTANCE RANGE UNLIMITED.

**Mignon Wireless Corporation**  
ELMIRA, N. Y., U. S. A.

WRITE FOR CATALOGUE AND MENTION WIRELESS AGE



A. H., Amherst, Ohio, inquires:

Ques.—(1) I have a secondary winding of a transformer which consists of 30,000 turns of No. 32 double cotton covered wire wound on pies of  $\frac{1}{4}$  inch thickness, 6 inches outside diameter,  $2\frac{1}{2}$  inches inside diameter, each pie containing 3,000 turns. Please give the dimensions for an appropriate primary winding.

Ans.—(1) The primary tube should be about 8 inches in length,  $2\frac{1}{2}$  inches outside diameter and 2 inches inside diameter. It should be wound with two layers of No. 12 double cotton covered wire.

Ans.—(3) A satisfactory diagram for the connection of the vacuum valve detector wherein the filaments of two valves are brought to incandescence by one battery, appears in Figure 19c, page 861 of the September, 1916, issue of this magazine.

Complete data for the windings of a small loose coupler for waves up to 400 meters appear in the last chapter of the book "How to Conduct a Radio Club." The dimensions are particularly suitable for the reception of short wave-lengths.

\* \* \*

The Tionesta Radio Club inquires:

Ques.—(1) We have a loose coupler especially constructed for the reception of signals from N. A. A., also a crystal detector, 1,000 ohms Red-Head receiver, fixed condenser, all connected to an aerial 100 feet in length, 25 feet in height, consisting of four wires. We get very loud signals from Arlington, with one-third the possible values of inductance in use, but do not seem to receive other stations using  $\frac{1}{4}$  k.w. set which are but eighteen miles distant.

Ans.—(1) It may be that the  $\frac{1}{4}$  k.w. transmitting set operates at the wave-length of 200 meters and your tuner is not constructed for sufficiently small values of inductance to permit adjustment to the shorter range of wave-length. You should take out a tap on the primary and secondary windings in order that small values of inductance may be obtained.

Ques.—(2) Please tell me the best length of an aerial and the dimensions of a receiving tuner for all around amateur work.

Ans.—(2) An aerial of the "T" type about 120 feet in length with an average height of 40 to 50 feet is best for all around work. A receiving tuner adjustable to wave-lengths between 200 and 3,000 meters will do for the average reception of signals. Of course, for the reception of undamped oscillations, a vacuum valve circuit of some type adjustable to waves between 6,000 and 10,000 meters should be provided.

A tuner responsive to waves between 200 and 3,000 meters should have dead end switches to cut off the unused turns of the primary and secondary windings when adjusted to the shorter wave-length. For maximum efficiencies it is advisable to construct a small receiving tuner for 200 meter reception only. A tuner of this type is described in connection with the portable set mentioned in the last

chapter of the book "How to Conduct a Radio Club." Receiving sets of this range are on sale by the Marconi Wireless Telegraph Company of America.

\* \* \*

S. W., West Philadelphia, Pa.:

A complete set of diagrams of connections for transmitting and receiving apparatus appears in the book "How to Conduct a Radio Club" on sale by the Book Department of the Wireless Press, Inc.

A crystal detector can be protected from the local transmitter by completely disconnecting it from the receiving circuit during the period of transmission. A double pole single throw knife switch should be connected to the binding posts of the detector. Each time the transmitting key is closed, this switch should be opened.

Galena and cerusite are the favorite sensitive crystals among amateurs.

\* \* \*

W. C. T., San Francisco, Cal.:

The condenser in the closed circuit of a radio transmitter increases the voltage provided a resonance transformer is employed, but whether or not the voltage is increased in other sets by this connection depends upon the overall design of the set. Unless designed for conditions of resonance or near to resonance, the presence of the condenser across the secondary winding may lower the secondary voltage.

The reading of an aerial ammeter on a radio set has been thoroughly explained in a previous issue of THE WIRELESS AGE. The meter in the antenna circuit, because of its low mechanical period as compared to the frequency of the oscillation, shows an accumulative reading of the energy flowing in two or three groups of oscillations, which may appear equal to the current input to the primary winding of the high potential transformer, but actually is not.

Merely connecting to earth the rotary spark gap of the standard 2 k.w. 500 cycle set has no effect upon the efficiency of the apparatus except to cause a slight loss of energy which may be due to the capacity effect between the closed circuit and the earth. Losses from this source are almost negligible.

\* \* \*

S. S., Danport, Conn.:

Dimensions for a  $\frac{1}{2}$  k.w. open core transformer follow: The core for the primary may be about 16 inches in length and about 2 inches in diameter, covered with Empire cloth and wound with two layers of No. 14 double cotton covered B. & S. magnet wire. The winding should be covered by a hard rubber tube or by ten or twelve layers of Empire cloth. The secondary winding may be made of ten to twelve sections of No. 30 B. & S. single covered silk wire. These sections will have an outside diameter of 6 inches and an inside diameter of about  $2\frac{1}{2}$  inches. Each will be about  $1\frac{1}{4}$  inches in thickness.

There is essentially no difference in the effi-

## GERMANY—ON AN 80 FOOT AERIAL

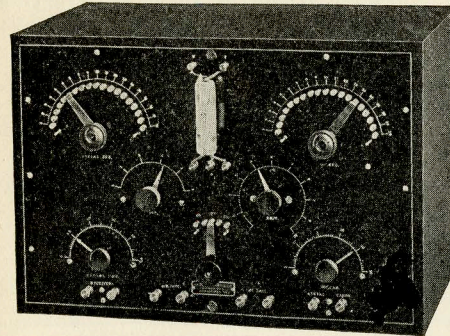

R-345 Undamped Panel Receiver.

You can read "POZ" (Nauen) and "OUI" (Hanover) daily on our 80 foot aerial with this

**MARVEL OF EFFICIENCY AND SIMPLICITY**

**PRICE 50% LOWER THAN OTHERS**

Send 2c. stamp for Bulletin No. 106.

**RADIO APPARATUS COMPANY, INC.**

Parkway Building,

Philadelphia.

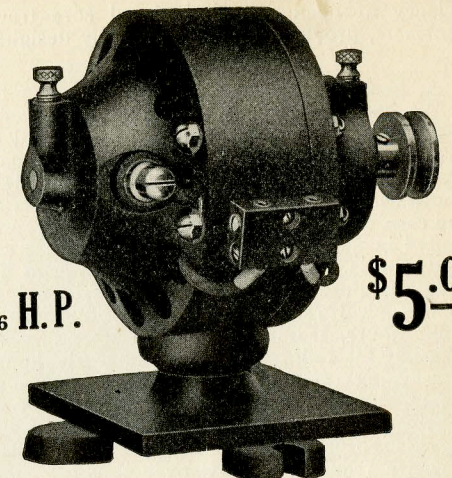

$\frac{1}{16}$  H.P.

\$5.00

6,000 r. p. m.

This Motor can be used for grinding, polishing, and as a general utility motor for the house. There is no better motor made for Spark Gaps. A powerful little motor, operating on A. C. or D. C. 100 to 130 volt.

Send Postage for Catalogue of Motors, Sparkgaps & El. Supplies

**FOSCO** 433 S. Dearborn Street  
CHICAGO, ILL.

Established 1905

**THE LUZERNE RUBBER CO.**

Manufacturers of Fine Quality

**HARD RUBBER GOODS**

STANDARD AND SPECIAL

Main Office and Factory:

TRENTON --:-- NEW JERSEY

**A. J. Cox & Company**

WESTERN REPRESENTATIVES

28 South Jefferson Street CHICAGO, ILL.

The Marconi Trans-Atlantic Wireless Telegraph Stations of America, Canada, England, and Italy are equipped with

**American Transformers**

made by specialists in the design and construction of transformers for extremely high potentials for testing, ozone generation, wireless work, etc.

**American Transformer Co.**  
NEWARK, N. J.

BIGLOW QUALITY STANDS FOR

**Tasteful Printing**

L. H. BIGLOW & COMPANY 62 BROAD STREET  
NEW YORK

**FREE**

While they last—we will send to every purchaser of Tel-Radion apparatus a FREE 60c copy of Coleman & Harriets edition of **RADIO STATIONS OF THE WORLD**

Order now as edition is limited  
Big Bargains in Receiving Stations

Our COMBINATION TYPE INDUCTIVE TUNER, Fixed Condenser, of exact capacity for this station, our No. C-22 Crystal Detector (having a lateral and horizontal motion making it easy to adjust), controlled by a rotary switch placed so as to permit a Tel-Radion Permanent Detector to be connected to this station if so desired, without changing the wiring. Complete as described \$10.00

The TEL-RADION DU-  
PLEX DETECTOR  
tunes separately to  
local or long distance  
stations, WITHOUT  
ANY ADJUSTMENTS.  
Price prepaid \$5.00

TEL-RADION CO.,  
32 Union Square, N.Y. C.

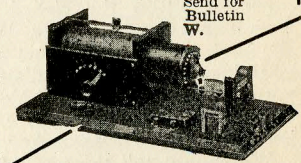

Telephone Bryant 5477

**Electrical Industries Mfg. Co.**

328 West 41st St.

New York



ciency of open core and closed core transformers, provided they are properly designed.

\* \* \*

A. E. G., Washington, D. C.:

We have no authentic information concerning the phenomenon apparently discovered by army engineers on the Mexican border, namely, the difference between daylight and night transmission in that region. The real facts of the case were probably inadvertently misrepresented in newspaper reports. The correct explanation is probably as follows: Owing to the severe atmospheric electricity experienced in semi-tropical regions, particularly during the night hours, it may have been necessary to transmit all radio reports in the early hours of morning. Generally static discharges are at a minimum during this period. It is a well known fact that a considerable amount of energy is absorbed from electric waves when they are required to pass over sandy wastes.

\* \* \*

N. G. S., South Hill, Va., inquires:

Ques.—(1) I am about to erect an aerial for a 1 k.w. transmitting set, and would like advice as to the proper type and length of such aerial. It is planned to use it for reception and transmission amateur wave-lengths from commercial stations.

Ans.—(1) Presuming that you will transmit at the wave-length of 200 meters and that you can erect an aerial of almost any type, we advise that you construct one of the "T" type, with a flat top portion consisting of four wires placed about 2½ feet apart. The horizontal portion may be 180 feet in length, but it should not be more than 40 feet in height. The lead-in wires are, of course, attached to the center.

The aerial wires can be purchased direct from any electrical supply houses, but silicon bronze is preferred by commercial operating companies.

Complete data for the wave-length of various types of aerials appear on page 109 of the November, 1916, issue of THE WIRELESS AGE.

\* \* \*

H. O. S., Bird Island, Minn.:

The diagram of connections for the receiving apparatus is correct, but that for the transmitting apparatus is incomplete. There is an open circuit in the closed oscillation circuit. Previous issues of THE WIRELESS AGE, and the book "How to Conduct a Radio Club" have contained a number of diagrams applicable to your transmitting set. You are advised to purchase this book or to examine back numbers of THE WIRELESS AGE.

We cannot tell the possible effect of a loading coil upon the wave-length of an aerial system without knowing the inductance and capacity of the antenna with which this is to be employed.

\* \* \*

M. B. W., Lima, Ohio:

The efficiency of the Marconi ½ k.w. 500-cycle transmitting set may be accounted for by good design throughout, and the elimina-

tion of energy losses. Your question is not thoroughly understood except in part, and the sketches you have made are not practical. The most efficient quenching is obtained when the closed oscillation circuit of the given transmitter oscillates just long enough to build up the current in the antenna circuit to its maximum value. The oscillations in the closed circuit should then cease and the aerial left to vibrate at its own natural frequency.

Best response is obtained in the telephone receiver when the sparks at the transmitter occur at rates of from 700 to 1,000 per second.

The spark frequency of 300 per second would not permit the oscillations in the antenna circuit to overlap one another unless very long wave-lengths were employed. A very much higher spark frequency is ordinarily employed to secure the overlapping of wave trains.

\* \* \*

L. M. S., Salem, Wis.:

You may be able to overcome your difficulties with the telephone company by running a triple braid conductor from the telephone pole to the house, using two wires for the regular telephone connection. The third wire is earthed at both ends. In one instance where a similar difficulty has been experienced the trouble has been completely eliminated by this connection.

\* \* \*

S. S. M., Winnipeg, Canada:

In Figure 4, page 187, of the December, 1916, issue of THE WIRELESS AGE, the two loading coils shown are mounted separate from the two coils marked "tuner." The latter coils have a lightning contact, while the loading coils have a multi-point switch. With this knowledge you should have no difficulty in constructing this apparatus after the description given by our contributor.

**FROM AND FOR THOSE WHO HELP THEMSELVES**

(Continued from page 421.)

joints in the pipe and a spark jumping from one point in the joint to another may cause an explosion. The best method of all is to make direct connection from the transmitting apparatus to the street side of the water mains in accordance with the Underwriters' requirements. Surface grounds work well, but amateurs located in large cities cannot employ one of this kind. If a surface ground can be used, it will prove efficient, but care should be taken that the wires composing it are laid directly underneath the antenna and also the conductor should be placed at least 6 or 8 inches below the surface of the earth.

MEREDITH B. LOWE, *Alabama.*

**THE Y. M. C. A. RADIO SCHOOL**

desires to open communication with young men wishing to qualify as

**Wireless Operators.  
Exceptional Opportunities**

Write for Booklet

**Y. M. C. A. Radio School**

157 East 86th Street  
New York, N. Y.

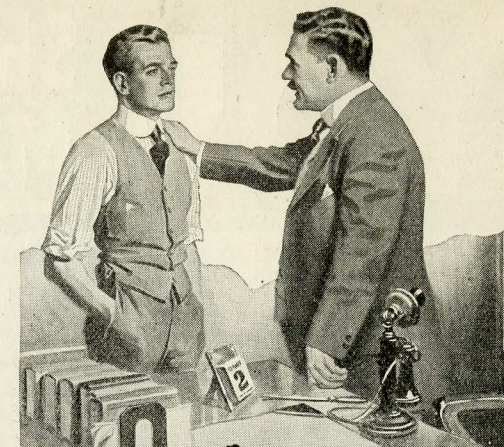

**Mr. Amateur**

You can become a licensed commercial operator through three months' evening study supervised by Marconi Co.'s Instructing Engineer. Our graduates enter the Marconi Service direct. Ask immediately about entrance requirements for this special short course, now beginning. Mention folder W.

**EASTERN DISTRICT Y. M. C. A.**

Marcy Ave., Near Broadway, Brooklyn, New York.

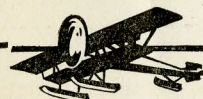

**WIRELESS**

operating spells OPPORTUNITY today. The great demand, rapid promotion and increased salaries make this work very attractive. We positively have good positions waiting for our graduates; operating in all parts of the world, coastwise, trans-atlantic, trans-pacific, etc., etc. Our special Spring class for Day and Evening students starts April 2nd. Easy payments if desired.

Send for special literature.

**Eastern Radio Institute**

899C Boylston St., Boston, Mass.

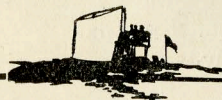

**"You Get The Job"**

"We've been watching you, young man. We know you're made of the stuff that wins. The man that cares enough about his future to study an I. C. S. course in his spare time is the kind we want in this firm's responsible positions. You're getting your promotion on what you know, and I wish we had more like you."

The boss can't take chances. When he has a responsible job to fill, he picks a man trained to hold it. He's watching you right now, hoping you'll be ready when your opportunity comes.

The thing for you to do is to start today and train yourself to do some one thing better than others. You can do it in spare time through the International Correspondence Schools. Over 5000 men reported advancement last year as a result of their I. C. S. training.

The first step these men took was to mark and mail this coupon. Make your start the same way—and make it right now.

**INTERNATIONAL CORRESPONDENCE SCHOOLS**  
Box 6011, SCRANTON, PA.

Explain, without obligating me, how I can qualify for the position, or in the subject, before which I mark X.

- |   |  |
|---|--|
| <input type="checkbox"/> ELECTRICAL ENGINEER        | <input type="checkbox"/> CHEMICAL ENGINEER                               |
| <input type="checkbox"/> Electrician                | <input type="checkbox"/> SALESMANSHIP                                    |
| <input type="checkbox"/> Electric Wiring            | <input type="checkbox"/> ADVERTISING MAN                                 |
| <input type="checkbox"/> Electric Lighting          | <input type="checkbox"/> Window Trimmer                                  |
| <input type="checkbox"/> Electric Car Running       | <input type="checkbox"/> Show Card Writer                                |
| <input type="checkbox"/> Heavy Electric Traction    | <input type="checkbox"/> Outdoor Sign Painter                            |
| <input type="checkbox"/> Electrical Draftsman       | <input type="checkbox"/> RAILROADER                                      |
| <input type="checkbox"/> Electric Machine Designer  | <input type="checkbox"/> ILLUSTRATOR                                     |
| <input type="checkbox"/> Telegraph Expert           | <input type="checkbox"/> DESIGNER  |
| <input type="checkbox"/> Practical Telephony        | <input type="checkbox"/> BOOKKEEPER                                      |
| <input type="checkbox"/> MECHANICAL ENGINEER        | <input type="checkbox"/> Stenographer and Typist                         |
| <input type="checkbox"/> Mechanical Draftsman       | <input type="checkbox"/> Cert. Public Accountant                         |
| <input type="checkbox"/> Machine Shop Practice      | <input type="checkbox"/> Railway Accountant                              |
| <input type="checkbox"/> Gas Engineer               | <input type="checkbox"/> Commercial Law                                  |
| <input type="checkbox"/> CIVIL ENGINEER             | <input type="checkbox"/> GOOD ENGLISH                                    |
| <input type="checkbox"/> Surveying and Mapping      | <input type="checkbox"/> Common School Subjects                          |
| <input type="checkbox"/> MINE FOREMAN OR ENGINEER   | <input type="checkbox"/> CIVIL SERVICE                                   |
| <input type="checkbox"/> Metallurgist or Prospector | <input type="checkbox"/> Railway Mail Clerk                              |
| <input type="checkbox"/> STATIONARY ENGINEER        | <input type="checkbox"/> Textile Overseer or Supt.                       |
| <input type="checkbox"/> ARCHITECT                  | <input type="checkbox"/> AGRICULTURE <input type="checkbox"/> Spanish    |
| <input type="checkbox"/> Architecture? Draftsman    | <input type="checkbox"/> Navigator <input type="checkbox"/> German       |
| <input type="checkbox"/> PLUMBING AND HEATING       | <input type="checkbox"/> Poultry Raising <input type="checkbox"/> French |
| <input type="checkbox"/> Sheet Metal Worker         | <input type="checkbox"/> Automobiles <input type="checkbox"/> Italian    |

Name \_\_\_\_\_  
 Present Occupation \_\_\_\_\_  
 Street and No. \_\_\_\_\_  
 City \_\_\_\_\_ State \_\_\_\_\_  
 If name of Course you want is not in this list, write it below.

# You Should be Earning More Money!



## Let Me Help You to a Bigger Salary—I Have Helped Thousands!

Are you discouraged with your job? Are you just a cog in the machinery, working long hours and getting starvation wages? I will train you for a splendid, worth-while position. I will show you how to double your income. You can be a success among big, successful men and women. You can get the best out of life and be somebody! Here's my advice:

### You Can Easily Learn Telegraphy—Morse and Wireless—Be Successful!

You can here learn to be a station agent, Western Union and railroad operator or a wireless operator all at the same time. I also give you a course of typewriting and penmanship free of additional charge. Expert instruction with practical work every day. I have two large modern buildings equipped with railroad and Western Union wires and two complete, late, modern, large Marconi Radio sets for instruction of wireless students. Splendid positions awaiting you with great chances for advancement. Wireless offers unusual opportunity for world travel.

### Positions Secured—Marconi Company Takes Our Wireless Graduates.

I have a contract with the Marconi Company whereby my students are given preference for positions as Wireless Operators on the Great Lakes and the Gulf of Mexico. Hundreds of our graduates now holding responsible positions. All attest to the efficiency and thoroughness of this school. No matter where you live you can reap the benefit of this institution's courses of training. It is the—

### Largest School—43 Years Old—Tuition Low—Easy Payments

600 students enrolled annually. \$25,000.00 investment. Valparaiso is an ideal, home-like town of 8,000 people. Come here, study a few months, change your whole life. Make a success of yourself! Correspondence courses, also. Be sure to write today.

**DODGE'S TELEGRAPH, RAILWAY AND WIRELESS INSTITUTE**  
Green Street, Valparaiso, Indiana

### Write Me a Personal Letter Today—Get Free Illustrated Catalog

*I want you to write me a long, heart-to-heart letter, telling me all about yourself and your present job. I assure you that I will do everything in my power to help you make the greatest success. Tuition rates are low. You can earn your living expenses while you are here. Many students are self-supporting.*

Sincerely,  
G. M. DODGE,  
Pres.

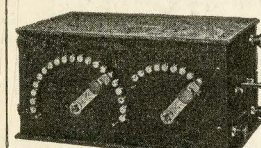

### Efficient Tuners at Lowest Prices

Increase your receiving distances by getting our efficient tuner, the biggest value ever offered for only \$8.00. Big Undamped Tuner only \$12.50. 15,000 Meter Loading Inductances with switches

only \$8.00. Send 2-cent stamp for bulletins.  
COLBY'S TELEGRAPH SCHOOL, AUBURN, N. Y.

## Learn Aviation

Mechanics of

Write today. See how you can learn the principles of Aeronautical Construction and Engineering in spare time at home. Save all the time and expense of laborious field training. Big opportunities now for trained Aviation Experts in different branches of the service. \$50 to \$250 a week

**Write At Once!** Big tuition reduction offer now open. Write for details while this offer lasts. No obligations. Write today—now!  
American School of Aviation, Dept. 1773 431 S. Dearborn St. Chicago

"THERE'S MONEY IN IT"

AT HOME **LEARN TELEGRAPHY** AT HOME

MORSE AND WIRELESS

**TEACH YOURSELF**

in half usual time, at trifling cost, with the wonderful Automatic Transmitter THE OMNIGRAPH. Sends unlimited Morse or Continental messages, at any speed, just as an expert operator would. Adopted by U. S. Government. 4 styles. Catalogue free.  
OMNIGRAPH MFG. CO., 39-C. Cortlandt St., New York



When writing to Advertisers please mention THE WIRELESS AGE

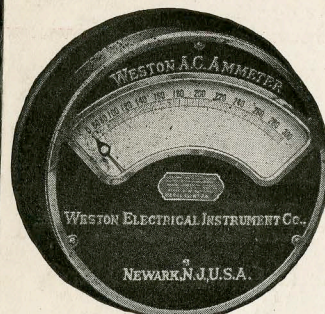

## The Art of Electrical Measurement

—its perfection and its growth, have been associated inseparably with this name—



From the year 1888 to now, each successive instrument that has borne the name has marked the highest achievement in the Art.

At no time has Weston superiority been more obvious than in the present models.

Weston Indicating Instruments include a great variety of groups for portable or switchboard service on A. C. or D. C. Circuits, and many for special purposes.

Weston Round Pattern Switchboard Instruments of 7-inch diameter are the standard for use on Wireless Telegraph Panels. As they are of the highest grade and designed for commercial installation, they are not adapted to experiments in wireless work. Write for more specific information.

**Weston Electrical Instrument Co.**  
27 Weston Ave., Newark, N. J.

New York  
Boston  
Philadelphia  
Pittsburgh  
Buffalo

Chicago  
Cleveland  
Cincinnati  
Richmond  
Detroit

St. Louis  
Denver  
San Francisco  
Winnipeg  
Toronto

Montreal  
Vancouver  
London  
Paris  
Petrograd



## LENZITE CRYSTAL DETECTOR

Patented May 2nd, 1916

### Why Is Our Detector Near Perfection?

1. "Lenzite," the new mineral substance, is acknowledged by leading authorities to be the best substance yet discovered for wireless detectors.
2. "Lenzite" is absolutely superior to any other electrolysis detector combination.
3. "Lenzite" is more economical than most others.
4. "Lenzite" is the most simple detector to manipulate.
5. "Lenzite" is the easiest to adjust and holds the adjustment better.
6. "Lenzite," although not permanent, is the only substance that does not lose its efficiency or effectiveness through excessive charges or excessive heat. In fact, it improves with such treatment.
7. "Lenzite" can be handled like any other crystal, no special care being necessary.
8. "Lenzite" is used exclusively in our detector and comes direct from our mines and is not purchased from different places.
9. "Lenzite" has the endorsement from Q. S. T., the official organ of the American Radio Relay League.
10. "Lenzite," if not satisfactory, we refund money on return of Detector within 30 days.

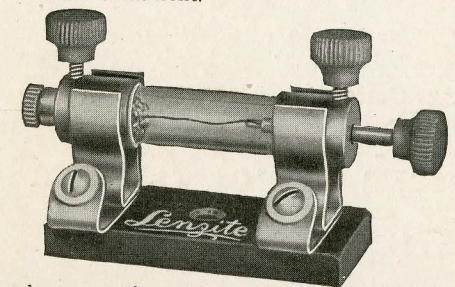

Send money order, express order or check for \$5.00 and we will send you, postage prepaid, one of our Lenzite wireless detectors.

**LENZITE CRYSTAL CORPORATION**  
537 Chamber of Commerce Bldg. Pasadena, California



## FOR THE NEW YEAR— JAPAN LINKED WITH AMERICA

Commercial wireless service between the Orient and Occident is Marconi's latest triumph in long distance communication.

From the new powerful and dependable duplex stations in California, near San Francisco, messages now flash daily across 6,512 miles of the Pacific Ocean to Funabashi, in Japan.

At Hawaii, the Crossroads of the Pacific, the largest wireless station in the world instantaneously relays these trans-oceanic marconigrams—signaling the union of the United States' prosperous island community with two continents.

One more link has been forged in the Marconi world-wide chain of service. With reliability, accuracy and economy, proven by performance, Marconi wireless offers the utmost in service and satisfaction.

*The new rates to the Orient are one-third and two-thirds lower than existing cable charges. Similar noteworthy reductions were made with the establishment of service to Alaska. Each year has ushered in new perfections and economies.*

Marconi wireless service is pre-eminent. For eight years trans-Atlantic service has been in daily operation—continent to continent—direct.

Within nineteen years of commercial life, Marconi wireless has become indispensable in the maritime field, invaluable in others. Regular communication has been established with ice-bound settlements and desert communities, and official running orders transmitted to moving railroad trains. Its service is dependable under all conditions, and embraces activities and locations inaccessible to any other telegraph system.

*More than 1,800 ships are equipped with Marconi wireless and its shore stations are landmarks in practically every country on the globe.*

Various types of Marconi equipment are designed for the merchant marine, warships, submarines, pleasure craft, motor cars and railroad trains; also portable signal corps sets, apparatus for aircraft, cavalry sets, knapsack sets and high-power installations for trans-ocean communication.

*Messages for transmission by wireless at reduced rates are accepted at the Marconi Office, 42 Broad Street, New York, and at all Western Union Offices in America and Canada.*

### Marconi Wireless Telegraph Co. of America

EDWARD J. NALLY, VICE-PRESIDENT AND GENERAL MANAGER

Woolworth Building, NEW YORK